

FieldSmart® Fiber Active Cabinet (FAC) 5400

Installation Manual



CLEARFIELD



FieldSmart® Fiber Active Cabinet (FAC) 5400

Installation Manual



Table of Contents	
About This Guide	5
Chapter 1: Fiber Active Cabinet 5400 Product Overview	6
Cabinet Description	7
Cabinet Features	8
Cabinet Options	9
Cabinet Dimensions and Weights	10
Cabinet Compartments	11
Chapter 2: Installation Considerations	14
Installation Process Overview	15
Installation Guidelines	16
Space Requirements	17
General Safety Recommendations	18
Installation Kit	19
User-Supplied Items	20
Cabling Requirements	21
Chapter 3: Preparing the Installation Site	22
Installing a Ground Circuit	23
Constructing a Concrete Pad	25
Pad Construction Guidelines	25
Assembling the Cast-In-Place Template	28
Preparing the Site	30
Casting the Pad	31
Installing a Pre-Cast Concrete Pad	32
Pre-Cast Pad Requirements	32
Preparing the Site	35
Installing a Pre-Cast Pad	36
Chapter 4: Installing the Cabinet	37
Unpacking the Cabinet	38
Operating Cabinet Doors	39
Preparing the Cabinet for Installation	41
Installing the Cabinet on a Concrete Pad	42
Replacing the Lifting Eye Bolts	45



FieldSmart® Fiber Active Cabinet (FAC) 5400

Installation Manual

Chapter 5: Installing Power	46
Installing the Cabinet Ground Connection.....	47
Installing AC Power (220-240 VAC).....	48
Installing AC Power (110-120 VAC).....	49
Chapter 6: Installing and Splicing Outside Plant Cables	51
Installing Metallic Cables.....	52
Installing Metallic Outside Plant Cables.....	52
Splicing Metallic Cables.....	54
Installing 5-Pin Protection Modules.....	55
Installing Fiber Cables.....	56
Installing Fiber Outside Plant Cables.....	56
Splicing Fiber Cables.....	58
Routing and Terminating Fibers.....	59
Sealing Cable Entry Locations.....	60
Chapter 7: Turning Up the Cabinet Power System	61
Checking the Ground Connection.....	62
Checking the AC Power Supply Voltage.....	62
Installing Rectifier Modules into the optional Valere Power Shelf.....	65
.....	65
Installing Batteries.....	67
Turning Up and Testing the DC Power System.....	70
Chapter 8: Installing Equipment and Adding Capacity	72
Installing a Protection Mounting Frame.....	73
Installing a Protection Block.....	74
Installing a Battery Heater.....	76
Installing an AC Meter.....	77
Installing a Generator Connector.....	78
Chapter 9: Cabinet Maintenance	81
Routine Maintenance.....	82
Battery Maintenance.....	82
Checking Electrical Components.....	83
Checking Cabinet Surfaces.....	84
Checking Cable Connections.....	84

FieldSmart® Fiber Active Cabinet (FAC) 5400

Installation Manual



Replacing Parts and Equipment.....	85
Replacing a Cabinet Door.....	85
Replacing AC Breakers.....	86
Replacing DC Breakers and Fuses.....	87
Replacing Rectifier Modules (for optional Valere Rectifier).....	89
.....	89
Replacing Batteries.....	91
Replacing a Battery Heater.....	92
Appendix A: Reference Information.....	93
Specifications.....	94
Supported Batteries.....	95
Rack Space for Additional Equipment.....	95
Valere Rectifier Alarm Matrix.....	96
Valere Rectifier Setpoints.....	97
Programming the Valere Shelf Controller.....	99
Rectifier Module Usage Guidelines.....	101
Wiring Diagrams.....	101
Standard Warranty.....	102
Proprietary Notice.....	103
Technical Support.....	103



FieldSmart® Fiber Active Cabinet (FAC) 5400

Installation Manual

About This Guide

Purpose

This document provides a general installation practice for the Clearfield FAC 5400 outdoor cabinet. This document also provides a general description of the cabinet and its subsystems, and guidance for planning, site preparation, power installation, splicing to the outside plant, component installation and expansion, and cabinet maintenance.

Intended Audiences

The information in this document is intended for use by network planning engineers, outside plant engineers, and field support personnel, as well as craft personnel responsible for cabinet installation, splicing, equipment installation, and maintenance.

Federal Communications Commission (FCC) Statement

Note: This equipment has been tested and found to comply with the limits for a Class A digital device, pursuant to Part 15 of the FCC rules. These limits are designed to provide reasonable protection against harmful interference when the equipment is operated in a commercial environment. This equipment generates, uses, and can radiate radio frequency energy, and, if not installed and used in accordance with the instruction manual, may cause interference to radio communications. Operation of this equipment in a residential area may cause harmful interference; the user will be required to correct the interference at his expense.

Safety Notices

This document uses the following safety notice conventions.



DANGER! Danger indicates the presence of a hazard that will cause severe personal injury or death if not avoided.



WARNING! Warning indicates the presence of a hazard that can cause severe personal injury if not avoided.



CAUTION! Caution indicates the presence of a hazard that can cause minor to moderate personal injury if not avoided.



ALERT! Alert indicates the presence of a hazard that can cause damage to equipment, damage to software, loss of data, or service interruption if not avoided.



DANGER! CLASS 1 LASER PRODUCT. INVISIBLE LASER RADIATION PRESENT. Fiber optic radiation can cause severe eye damage or blindness. Do not look into the open end of an optical fiber.

FieldSmart® Fiber Active Cabinet (FAC) 5400

Installation Manual



Chapter 1: Fiber Active Cabinet 5400 Product Overview

This chapter provides a general description of the Clearfield FAC 5400 outdoor cabinet, including its standard features and options.

Topics Covered

This chapter covers the following topics:

- A description of the FAC 5400 cabinet.
- A list of cabinet features.
- A list of cabinet options.
- A view of the cabinet dimensions.
- Views of the cabinet compartments.



FieldSmart® Fiber Active Cabinet (FAC) 5400

Installation Manual

Cabinet Description

The Clearfield FAC 5400 cabinet is an environmentally-controlled outdoor enclosure designed to house and protect network electronics equipment. Use the FAC 5400 to provide network services from a remote location, extending the service area beyond the reach of the carrier Central Office.



The FAC 5400 cabinet supports high density fiber and copper plant terminations, enabling deployment of a broad suite of applications from a single node. The cabinet's main electronics compartment is equipped with 23-inch front and rear equipment racks that provide a total of 54 RU of mounting space. The hinged racks swing outward up to 90 degrees, providing easy backplane access to all mounted equipment.

The flexible, modular design of the FAC 5400 enables incremental field expansion of system capacity, lowering initial deployment costs while maintaining the capacity for future growth. Modular components designed for capacity expansion include fiber splicing and distribution, modular copper line protection, thermal management, and battery support.

FieldSmart® Fiber Active Cabinet (FAC) 5400

Installation Manual



Cabinet Features

Standard features of the FAC 5400 cabinet include:

Enclosure Design

- Environmentally sealed design protects from dust and water intrusion
- Compartmentalized for safety, including separate vented battery compartment
- Environmental and intrusion alarm systems
- GR-487 compliant and UL-60950/UL-50 spec
- Environmentally rated from -40C to +46C (per GR-487)

Equipment support

- Door-mounted heat exchangers (2) provide 3700W of cooling capacity
- Swing out, 23-inch front and rear equipment racks
- 54 RU total mounting space for equipment (27 RU per side)
- Mechanical support for high density fiber and copper plant terminations
- Modular, scalable copper line protection (50-pair block increments)

Power

- 120/240 VAC load center (UL-listed); 60 Amp capacity
- AC service disconnect breaker
- AC surge suppressor (Joslyn)
- Redundant AC supplies to DC power system
- Convenience outlets (GFCI protected)
- Optional Valere compact DC power system (with distribution)
- Redundant DC supplies to equipment (A and B)
- Low voltage DC disconnect (-42V)
- Up to 340Ah battery reserve capacity (NSB 170FT)



FieldSmart® Fiber Active Cabinet (FAC) 5400

Installation Manual

Cabinet Options

Common options for the FAC 5400 cabinet include:

Enclosure Mounting

- Site-cast concrete pad using Clearfield template
- Pre-cast concrete pad

Power

- 220/240 VAC input, reconfigurable for 110/120 VAC (requires 20A rectifier modules)
- Generator connector (Hubbell); 30
- N+1 rectifier redundancy; 30A or 20A modules (20A only for 110/120 VAC input)
- Support for AC meter mounting

Battery Support

- Battery heater kit
- Northstar (OEM) battery string and installation kit

Copper Protection & Splicing

- Copper line protection for 480 or 960 lines; MS2 or 710 interface connectors
- 2:1 URLs cross-connect (2000 subscriber/1000 equipment pairs); MS2 interface connectors

Fiber Management

- Fiber splice tray holder (3 RU), holds up to 10 splice trays; each tray holds up to 12 fiber splices (fusion, mechanical, heat shrink options)
- Fiber distribution panel (1 RU); 12 or 24 positions (SC, LC, ST, FC connector options)
- Fiber distribution cassette holder (6 RU), holds up to six cassettes; each cassette has 12 fiber positions (SC or LC connector options)

Third Party Equipment Support

- Test head installation kits
- Splitter kits (1:32 PON or xDSL/POTS)
- CWDM EDFA mounting kit (for FTTP RF video applications)

FieldSmart® Fiber Active Cabinet (FAC) 5400

Installation Manual



Cabinet Dimensions and Weights

The external dimensions of the FAC 5400 cabinet are shown below.

Dimension	Measurement (SAE)	Measurement (Metric)
Height	73.50 inches	187 cm
Width	48.50 inches	123 cm
Depth	48.50 inches	123 cm

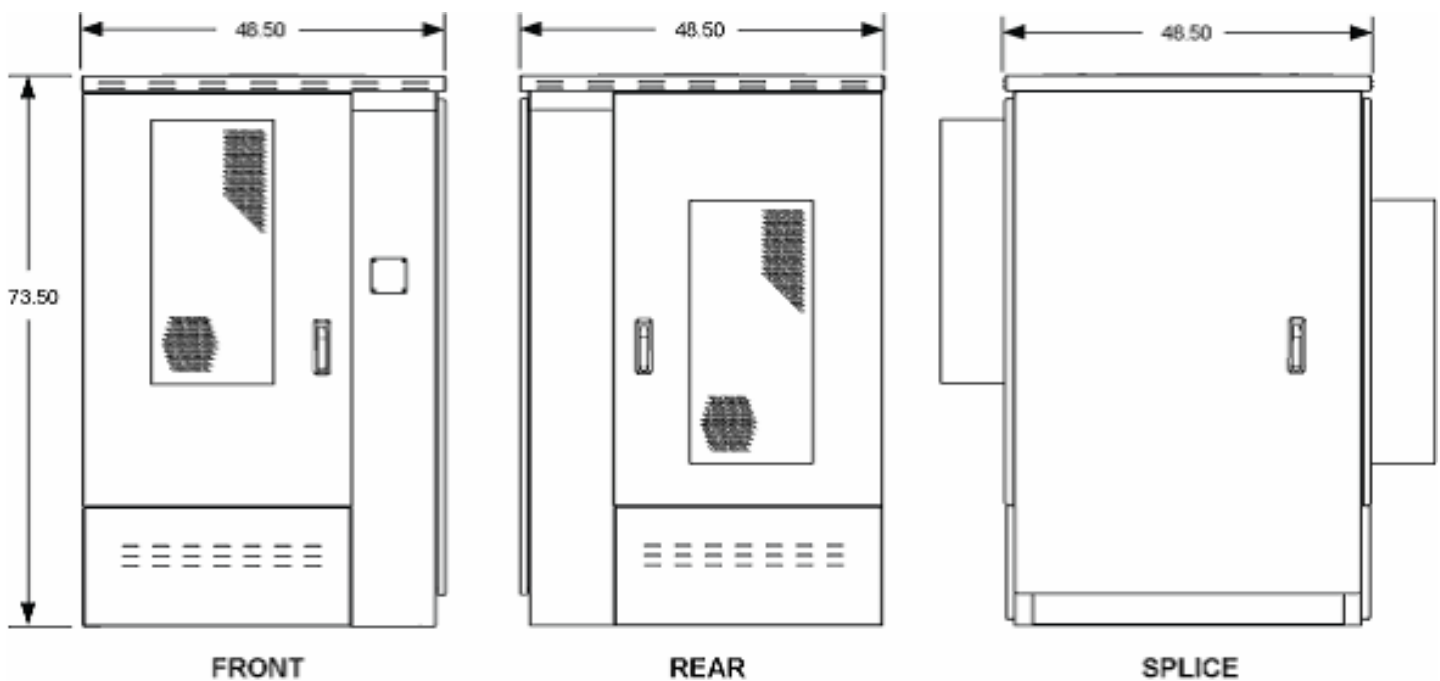

The approximate shipping weights of the FAC 5400 cabinet are shown below.

Configuration	Weight (SAE)	Weight (Metric)
960 lines (standard)	1271 lb	577 kg
960 lines (cross-connect)	1435 lb	651 kg



FieldSmart® Fiber Active Cabinet (FAC) 5400

Installation Manual

Cabinet Compartments

Views of the FAC 5400 cabinet compartments follow.

Front Compartment

The front compartment provides 47 inches of vertical rack space (27 RU). The front compartment typically houses an optional Valere power system, leaving 21 RU of rack space for additional equipment. The swing frame rack design allows for easy access to the backside of the mounted equipment.



FAC 5400 Front

FieldSmart® Fiber Active Cabinet (FAC) 5400

Installation Manual



Rear Compartment

The rear compartment provides 47 inches of vertical rack space (27 RU). The rear compartment houses no standard equipment, leaving the full 27 RU of rack space available for optional or third-party equipment. When the cabinet is configured with an optional cross-connect panel, the rear compartment houses the copper line protection that otherwise resides in the splice compartment. The swing frame rack design allows for easy access to the backside of mounted equipment.



FAC 5400 Rear



**FAC 5400 Rear
(cross-connect)**



CLEARFIELD

FieldSmart® Fiber Active Cabinet (FAC) 5400 *Installation Manual*

Splice Compartment

The splice compartment provides 67 inches of vertical rack space (38 RU). The splice compartment houses the AC load center and main ground bar and provides the cable entry locations. The splice compartment also typically houses the copper line protection, which consists of up to four rack-mounted protection frames, each holding up to six modular 50-pair protection blocks. When the cabinet is configured with an optional cross-connect panel, the cross-connect panel resides in the splice compartment and the protection shifts to the rear compartment. The modular design of the copper line protection and cross-connect systems allows for incremental expansion of capacity if required.



FAC 5400 Splice Side



**FAC 5400 Splice Side
(cross-connect)**

Battery Compartment

The battery compartment houses up to two strings of front-access VRLA batteries (1.5 strings per side). The battery compartment is equipped with a GFCI-protected duplex outlet to support an optional battery heater/



**Batter Compartment
(front)**



**Battery Compartment
(rear)**

FieldSmart® Fiber Active Cabinet (FAC) 5400

Installation Manual



Chapter 2: Installation Considerations

This chapter provides general considerations for cabinet installation. Review this information before starting the cabinet installation process.

Topics Covered

This chapter covers the following topics:

- Installation process overview
- Installation guidelines
- Space requirements
- General safety recommendations
- Installation kit contents
- User-supplied items
- Cabling requirements



FieldSmart® Fiber Active Cabinet (FAC) 5400

Installation Manual

Installation Process Overview

The cabinet installation process involves the following high-level steps:

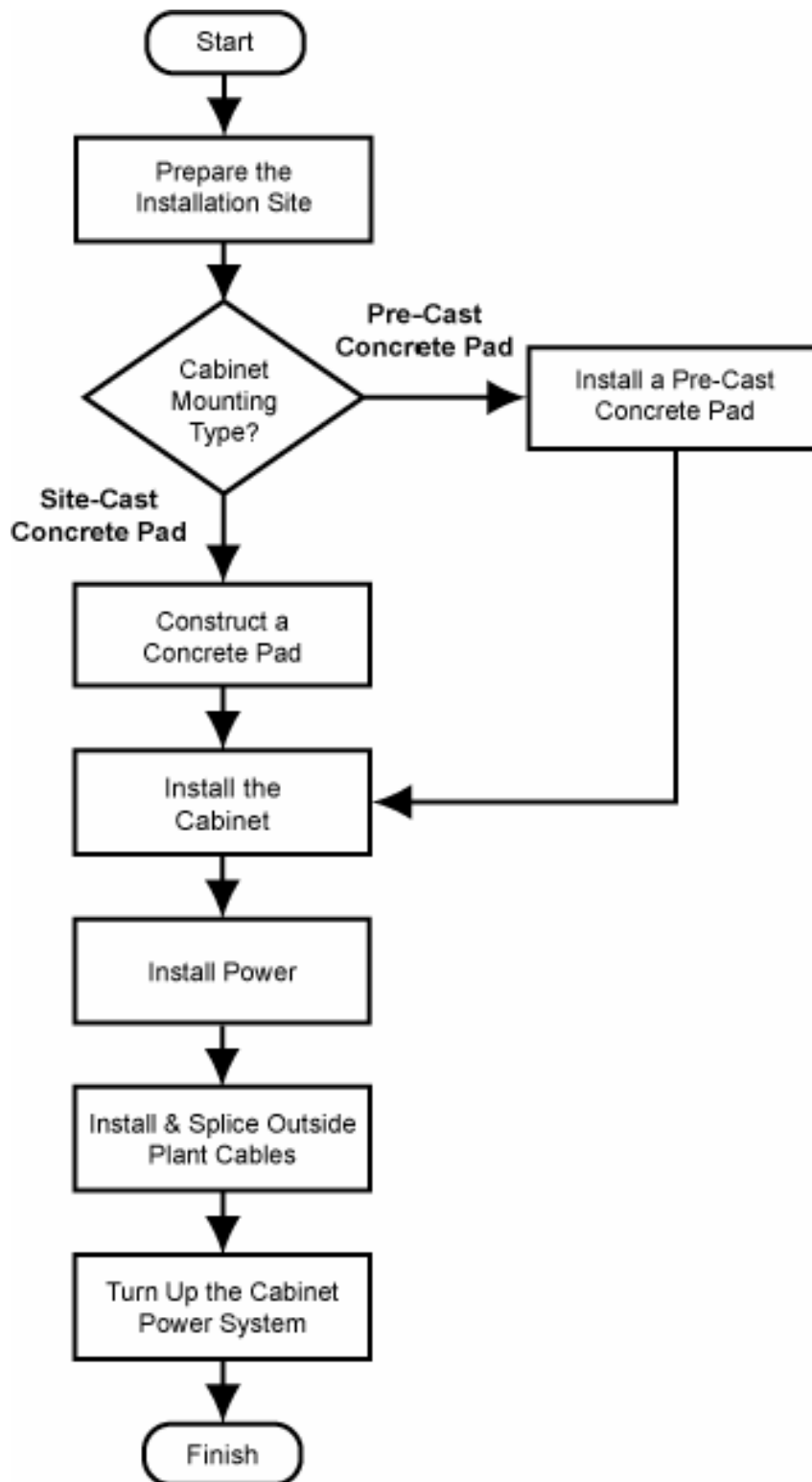

FieldSmart® Fiber Active Cabinet (FAC) 5400

Installation Manual



Installation Guidelines

Review the following guidelines before starting installation activities.

General Guidelines

Follow these general guidelines and practices:

- Read this document completely before starting any installation activities.
- Only qualified personnel should perform the procedures described in this document.
- Follow standard safety precautions when performing installation and maintenance tasks.
- Always wear standard safety gear when performing installation and maintenance tasks (hardhats/safety headgear, eye protection, insulated gloves).
- For safety, keep bystanders and other unauthorized personnel away from work operations at all times.
- Do not perform installation activities during thunderstorms or when the threat of lightning is present.
- **Warning!** Seal all cable entry locations immediately after the cabinet is installed to prevent ground moisture from condensing inside the cabinet and damaging equipment.

Site Selection

The location of a cabinet installation site should be carefully planned in advance. Consider the following factors when selecting an installation site:

1. Functional requirements:

- **Suitable terrain.** Whenever possible, the cabinet should be located in an area with a firm flat soil surface that does not require extensive earth work. The location should not be constantly damp or prone to flooding. Check soil maps of potential sites for subsurface conditions.
- **Grounding properties.** The earth at the cabinet location should have a low ground impedance to provide an effective grounding system for lightning protection and safety. Perform ground testing to determine the grounding requirements.
- **Safety.** Whenever possible, the cabinet should be located on vacant property away from motor traffic to reduce injury risks to maintenance personnel or damage to equipment. On streets and highways, avoid locations near busy intersections or curves in the road. Erecting guard rails or concrete pillars can provide additional safety barriers against motor traffic.
- **Solar exposure.** Whenever possible in hot or warm climates, avoid locations with heavy exposure to direct afternoon sun, so as to maximize the life of electronics equipment in the cabinet. High outdoor temperatures and heavy solar exposure raise temperatures inside cabinets, a condition that can reduce the life span of equipment. Conversely, wind exposure improves thermal conditions in a cabinet, so locations that do not block wind are desirable.



FieldSmart® Fiber Active Cabinet (FAC) 5400

Installation Manual

2. Accessibility requirements:

- **Electrical access.** Cabinets must have access to commercial AC power. Verify the availability of AC service at potential cabinet locations.
- **Easement size.** Select a location with an easement that provides enough space to walk around the perimeter of the cabinet with its doors open.
- **Right-of-Way.** Secure a permanent location on private property, whenever possible. Obtain a firm right-of-way agreement that includes right of access. Avoid locations in public rights-of-way.
- **Parking.** Whenever possible, the cabinet should be located in an area that provides sufficient parking space for installation and maintenance vehicles.

Space Requirements

The illustration below shows the cabinet clearance and space requirements.

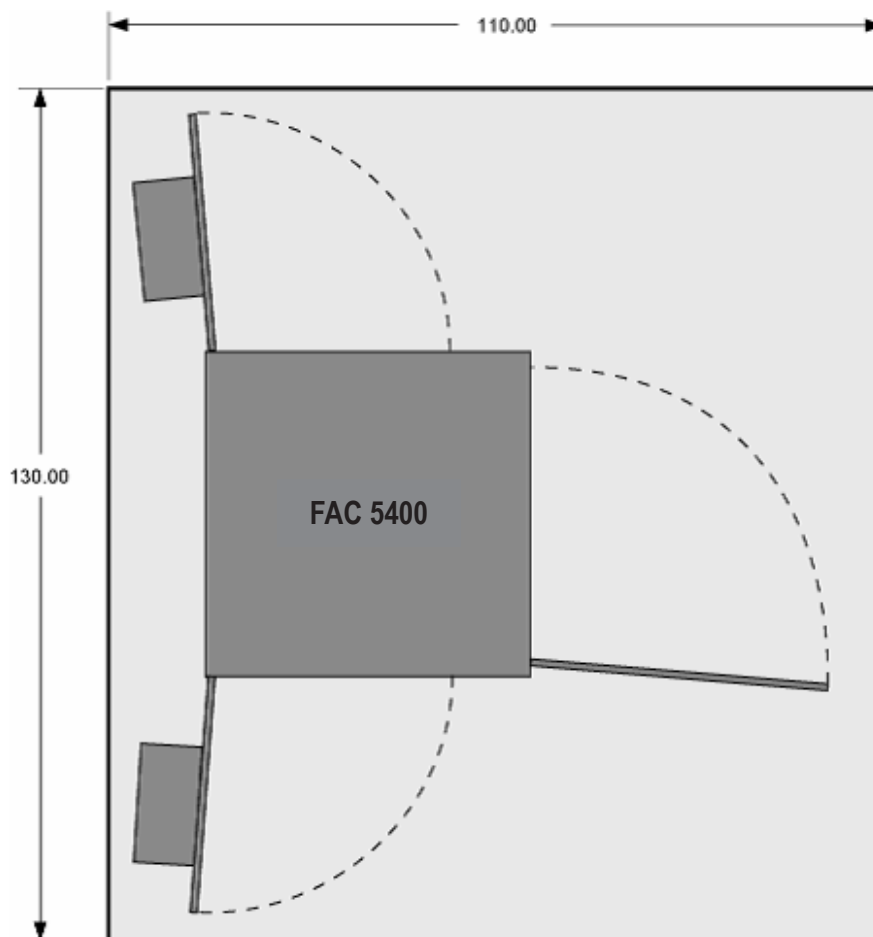

The minimum clearance area around the cabinet site must be free of permanent impediments to allow full swing of the cabinet doors. This area must be kept clear of obstructions at all times to provide adequate access for all installation and maintenance activities.

FieldSmart® Fiber Active Cabinet (FAC) 5400

Installation Manual



General Safety Recommendations



WARNING! Only trained, qualified technical personnel should perform the procedures described in this document. These procedures involve potentially hazardous activities, including handling of heavy equipment and exposure to high electrical energy, that could cause injury to untrained personnel.



DANGER! Risk of high power current surge and electric shock. Read and understand all power procedures before performing tasks. Take necessary precautions and use appropriate insulated tools when working with power. This equipment must be installed, operated, and serviced by qualified technical personnel only.



WARNING! The cabinet and its components are heavy. Handle with care to avoid personal injury or damage to the equipment.



DANGER! CLASS 1 LASER PRODUCT. INVISIBLE LASER RADIATION PRESENT. Fiber optic radiation can cause severe eye damage or blindness. Do not look into the open end of an optical fiber.



CAUTION! Batteries contain a stored charge. Handle batteries with care.



ESD ALERT! Beware of electrostatic discharge. Follow standard ESD precautions. Always wear a grounded ESD wristband to avoid damaging the electronic equipment.



FieldSmart® Fiber Active Cabinet (FAC) 5400

Installation Manual

Installation Kit

Clearfield supplies an installation kit with the cabinet that includes materials required for installation. The installation kit contents are listed below. Check to verify that your kit contains all of the listed items.

<input checked="" type="checkbox"/>	Qty	Item Description
	1	Telco hex key, 5/16" (for cabinet door)
	1	Isolation mat (for pad mounting)
	4	Hex nuts (for pad mounting)
	4	Square washers (for pad mounting)
	4	Split lock washers (for pad mounting)
	4	3/4" hex head bolts (for replacing lifting eye bolts)
	24	12-24 hex mounting screws
	1	Jumper cable (for battery string #3); 10 AWG, white
	1	T1 slot identification labels; sheet of 40 (for protection blocks)
	1	Sealant mix for cable entry locations (750g bag)
	1	Torx driver T20 (for access to heat exchanger components)

FieldSmart® Fiber Active Cabinet (FAC) 5400

Installation Manual



User-Supplied Items

Supply the following items for cabinet installation.

Tools

Bring the following tools to the installation site:

- Power drill with universal socket and screwdriver bit sets
- Socket wrench/nut driver set (standard)
- Screwdriver set (standard)
- Box wrench set (standard)
- Beam Level
- Insulated needle-nose pliers
- Wire stripper
- Compression crimping tool
- Fiber cleaver
- Fiber splicer
- Modular MS2 or 710 splicing tool

Materials

Bring the following materials to the installation site:

- Two-hole compression lug (3/4" hole spacing) for #2 AWG earth ground wire
- Strain relief for #2 AWG earth ground wire
- Strain relief for #6-8 AWG AC supply wiring
- MS2 or 710 connectors for copper line splicing
- Silicone sealant

Equipment

Bring the following equipment to the installation site:

- Boom crane or derrick capable of lifting a 3000 lb load
- Four (4) wire rope slings, minimum 6 foot length each
- Five (5) connecting links or lifting hooks
- Four (4) shims
- Digital multi-meter
- Optical power meter
- Digital multi-function test set



FieldSmart® Fiber Active Cabinet (FAC) 5400

Installation Manual

Cabling Requirements

Cables supplied to the cabinet must meet the following minimum requirements.

Function	Facility	Requirements
Power		
Ground	Copper	2 AWG solid bare copper wire (to earth ground circuit); terminates to ground bar with 2-hole compression lug
AC	Copper	6 to 8 AWG; Follow National Electric Code (NEC) and local codes

Note: Local climatic conditions, site conditions, or local practices may require adjustments to cabling requirements.

FieldSmart® Fiber Active Cabinet (FAC) 5400

Installation Manual



Chapter 3: Preparing the Installation Site

This chapter describes how to prepare the FAC 5400 installation site for cabinet placement, including establishing the cabinet mounting structure. You can install the cabinet onto a concrete foundation pad.

For pad-mounted configurations, you can construct a concrete pad using the Clearfield cast-in-place template, or you can purchase a pre-cast concrete pad from a third-party supplier.

For all mounting configurations, Clearfield requires installation of an earth ground circuit at the installation site to provide lightning protection.

Topics Covered

This chapter covers the following topics:

- Installing a ground circuit at the installation site.
- Constructing a concrete pad.
- Installing a pre-cast concrete pad.



FieldSmart® Fiber Active Cabinet (FAC) 5400

Installation Manual

Installing a Ground Circuit

Clearfield requires installing an earth ground circuit (earth electrode) at the installation site to provide protection from electric shock for equipment and personnel. The ground circuit may consist of a simple copper rod driven into the earth or a complex system of buried rods and wires. The lower the resistance of the electrode-to-earth connection, the more effective the ground system for safety and lightning protection.

Proper grounding conditions and requirements vary per site. The National Electric Code (NEC) specifies a maximum ground impedance of 25 ohms. Clearfield recommends achieving a ground impedance of no greater than 5 ohms wherever practical. If 5 ohms or less cannot be achieved, the maximum ground impedance should meet local codes or the NEC requirement of 25 ohms, whichever is less.

Grounding options

The cabinet main ground system must be bonded to a suitable earth ground circuit, which may include any of the following:

- **Ground rod(s):** A ground rod consists of a simple copper rod driven into the earth. A ground rod connects to the main cabinet ground via an earth ground wire (2 AWG solid bare copper) bonded to the ground rod and buried at the site. Multiple inter-connected ground rods provide increased ground electrode-to-earth conductivity. You can add supplemental ground rods to a single ground electrode in several arrangements, including a linear chain, fan array, or ring configuration. Refer to the NEC or local regulations for restrictions and details. All bonds to grounding electrodes must be suitable for direct burial using irreversible mechanical connections or exothermic welds. Follow local code or site practice to satisfy any additional grounding requirements.
- **Ground ring:** A ground ring consists of multiple ground rods that encircle the perimeter of a site. *Ground rings represent the preferred earth grounding system for cabinet deployments.* Ground rings follow the provisions for multiple ground rods, with an additional NEC provision that the ground rings should consist of at least 20 feet of bare copper conductor not smaller than 2 AWG.

FieldSmart® Fiber Active Cabinet (FAC) 5400

Installation Manual



Ground circuit considerations

Following local codes and practices, install a ground circuit at the installation site. Consider the following factors when constructing the ground circuit:

- The ground electrode(s) should be copper-clad steel at least 1/2-inch in diameter.
- The ground electrode(s) should have a minimum of 6 feet of direct contact with earth.
- The ground electrode(s) should be located no closer than 24 inches from the outside perimeter of the cabinet pad or pole.
- The wire connecting multiple electrodes should be 2 AWG bare copper or larger, and should be buried at least 24 inches deep or below the frost line (whichever depth is greater).
- The wire connecting multiple electrodes should be connected with an exothermic weld or irreversible mechanical connector suitable for direct burial.
- The wire connecting the cabinet main ground bar to the initial ground electrode should be a 2 AWG or larger bare copper ground wire.
- The ground wire should enter the cabinet separated from power or copper transmission cables. Never bundle the ground wire together with other copper cables.
- Connect the ground wire to the main ground bar.

Follow local code to satisfy additional requirements, if applicable.



FieldSmart® Fiber Active Cabinet (FAC) 5400

Installation Manual

Constructing a Concrete Pad

A concrete pad provides a permanent foundation to anchor the cabinet to the ground while protecting the cabinet from water damage and other outdoor surface conditions.

Construct a concrete foundation pad for the cabinet at the installation site. Pad construction requires excavating the site, trenching cable conduit, constructing a form, and casting concrete. Use the Clearfield-supplied cast-in-place template to provide exact locations for the mounting studs that anchor the cabinet to the pad and to provide the cable conduit locations.

Pad Construction Guidelines

When constructing a concrete pad, observe the following guidelines and refer to the pad drawings for guidance.

Guidelines

Follow these guidelines to ensure proper pad construction. Adjust for local conditions or practices as required.

- Construct the pad with minimum perimeter dimensions of 110 x 130 inches.
- Construct the pad with a minimum height of 6 inches.
- Construct the pad with a maximum of 2 inches above-grade exposure.
- Use the Clearfield cast-in-place template to provide exact mounting stud and conduit locations.
- Use rebar or wire mesh inside the form to improve pad strength.
- Cast the pad from a single concrete pour. Do not make multiple pours.
- Use 4-inch conduit (maximum) for outside plant cables. See drawing below for entry locations.
- Use 2-inch conduit (maximum) for AC cable. See drawing below for entry location.
- Include pull cords in all cable conduits.

FieldSmart® Fiber Active Cabinet (FAC) 5400

Installation Manual



Pad Drawings

Use the following drawings for reference during pad construction.

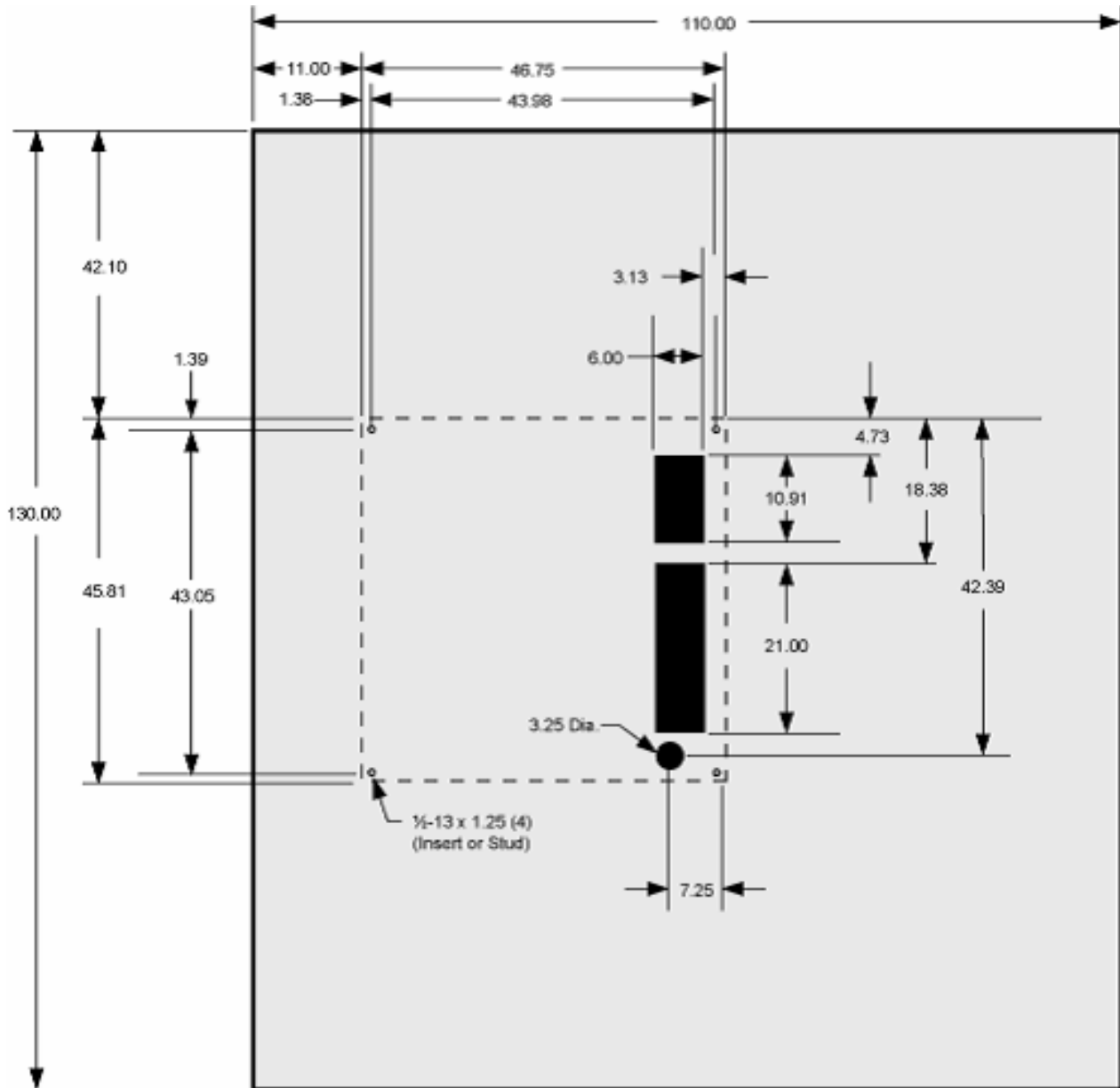

Pad Size



FieldSmart® Fiber Active Cabinet (FAC) 5400

Installation Manual

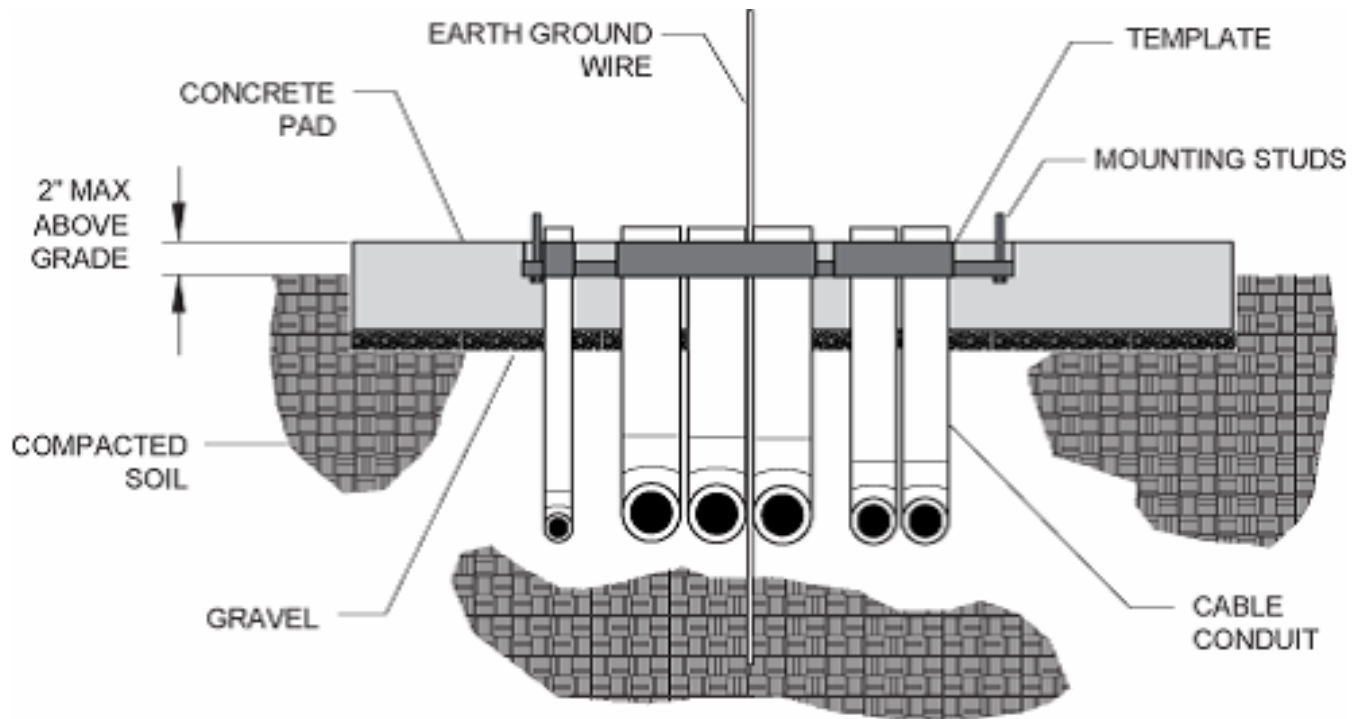

Pad Cross-Section

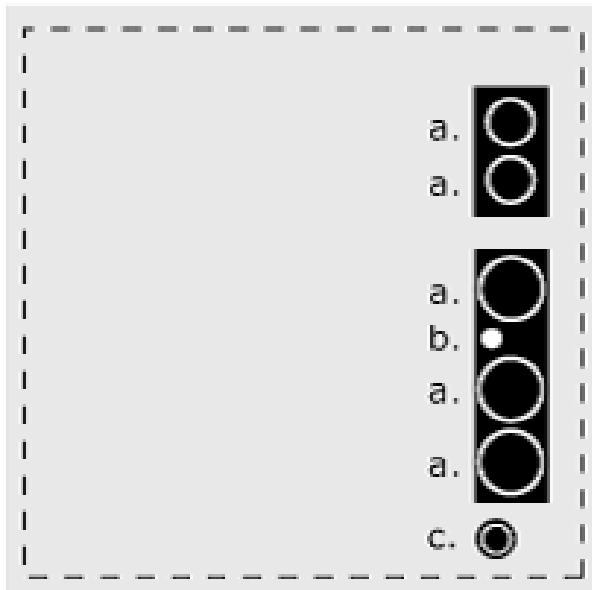

Conduit Locations

For proper cable entry into the cabinet, place conduit into the following locations.

- a. Conduit for outside plant cable.
- b. Earth ground wire (preferred location for direct connection to cabinet ground bar).
- c. Conduit for AC cable.

Use the Clearfield cast-in-place template to provide precise conduit orientation.

FieldSmart® Fiber Active Cabinet (FAC) 5400

Installation Manual



Assembling the Cast-In-Place Template

Assemble the Clearfield cast-in-place template as follows.

To assemble the template

Step 1: Unpack the template hardware from the shipping kit.

Step 2: Place the four bracket members on the ground and arrange as follows:

- Place the two long brackets parallel with each other, with the labels (Front, Rear) up and the arrows pointing toward the outside.
- Place the two short brackets between (and perpendicular to) the long members, with the labels (Left, Splice) up and the arrows pointing toward the outside.

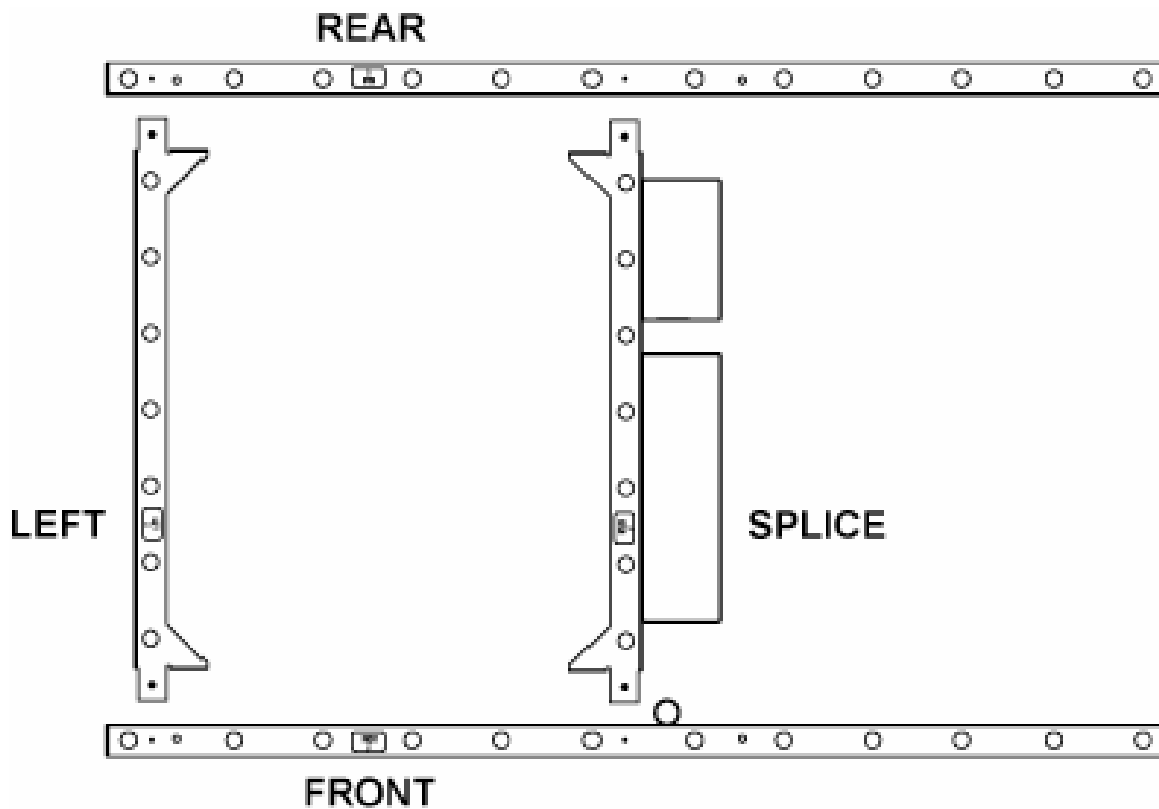

Step 3: Align the Left bracket screw holes with the counterpart holes on the Front and Rear brackets.

Step 4: Align the Splice bracket screw holes with the counterpart holes on the Front and Rear brackets.



FieldSmart® Fiber Active Cabinet (FAC) 5400

Installation Manual

Step 5: Install the eight supplied screws (with washers) into the threaded screw holes to connect the brackets together. Use two screws at each junction point as shown.

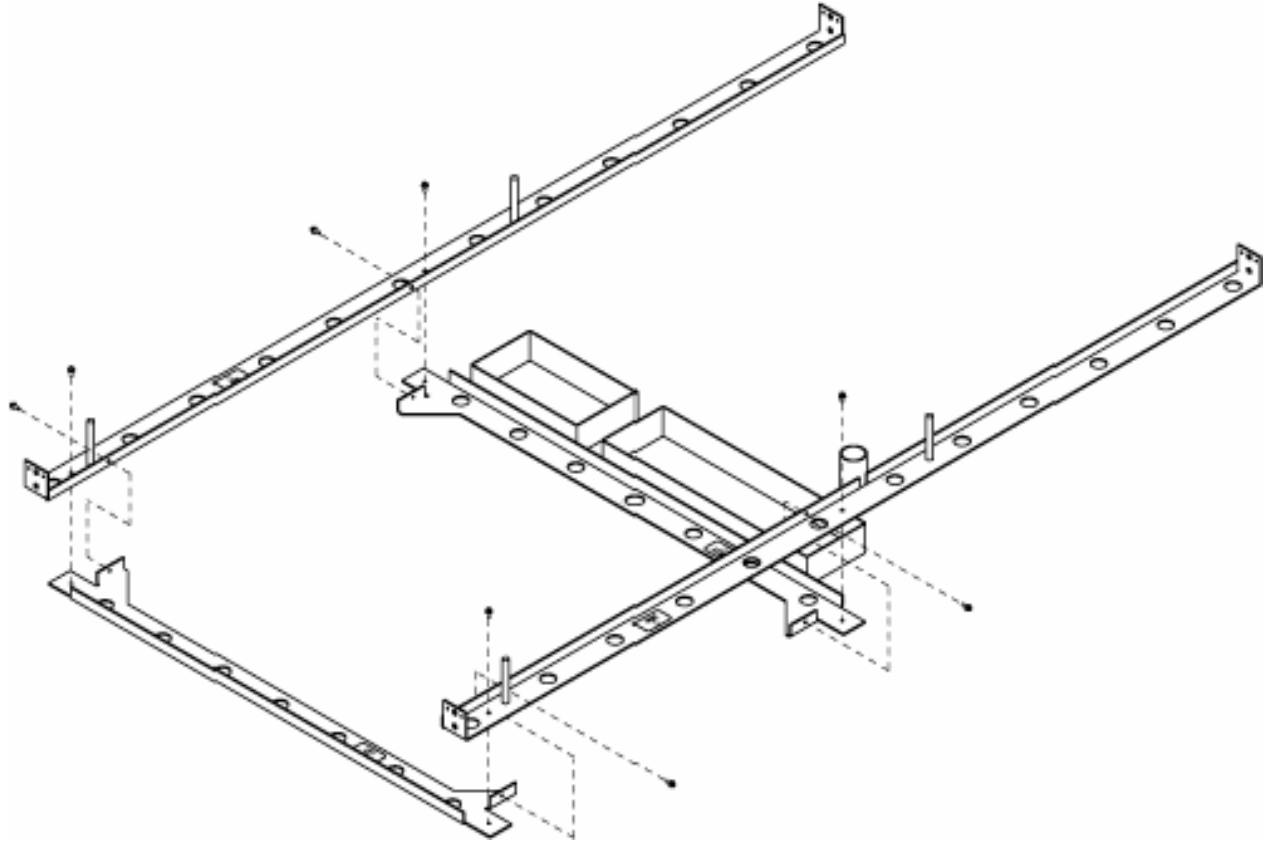

Step 6: Tighten all screws to complete the template assembly.

FieldSmart® Fiber Active Cabinet (FAC) 5400

Installation Manual



Preparing the Site

Prepare the site for pad construction as described below. Adapt the instructions as needed for local requirements, practices, or conditions.

To excavate the site

- Step 1:** Excavate the pad area. Dig a foundation hole six inches deep with a perimeter measuring at least 110 x 130 inches.
- Step 2:** Grade and compact the excavated surface until it is firm and level.
- Step 3:** Trench out conduit paths through the foundation hole (from the cable feeder location). Refer to the *pad drawings* for conduit locations.
- Step 4:** Place the cable conduits into the conduit trench. Refer to the *pad construction guidelines* for conduit sizes and locations.
- Step 5:** Route the earth ground wire through the conduit trench (from the ground electrode).

To construct a concrete form

- Step 1:** Using wooden boards and stakes, construct a concrete form with interior dimensions of 110 x 130 inches (minimum) inside the foundation hole. Make sure that the top edge of the form is level.
- Step 2:** Place gravel into the foundation hole to create a level base. The gravel layer should be at least two inches deep, compacted and leveled.
- Step 3:** Place and tie rebar inside the form elevated above the gravel.
- Step 4:** Place the Clearfield cast-in-place template into the form, guiding the cable conduits through the conduit entry ducts in the template.
- Step 5:** Align the template mounting brackets flush with the top of the form, then nail the template to the form to secure it in place.

Note: *The mounting studs should protrude approximately 2 inches above the form.*

- Step 6:** Verify that the form remains level across the entire surface. Adjust as required.
- Step 7:** Pull the earth ground wire (from the conduit trench) through the center entry duct in the template, allowing at least four feet of wire to extend above the top of the form.
- Step 8:** Mask the four mounting studs on the template to protect the threads from concrete.



FieldSmart® Fiber Active Cabinet (FAC) 5400

Installation Manual

Casting the Pad

Cast the concrete foundation pad as described below. Adapt the instructions as needed for local requirements, practices, or conditions.

To cast the concrete pad

Step 1: Prepare the concrete mix. Be sure to mix enough concrete to cast the entire pad in a single pour.

Note: To avoid structural weakening, do not cast a pad from multiple concrete pours.

Step 2: Pour the concrete into the form. Do not allow the cast-in-place template to bend or twist out of shape during the pour.

Step 3: Smooth and level the top surface of the concrete.

Step 4: Leave the pad to cure. Do not remove the form until the concrete has fully cured (at least 72 hours).

Perform the remaining steps only after the concrete has cured.

Step 5: Remove and discard the form.

Step 6: Backfill the cable conduit trenches with gravel as required.

Step 7: Backfill and grade the perimeter area around the pad with dirt, as required.

Step 8: Trim the cable conduits to a height no more than 4 inches above the pad.

FieldSmart® Fiber Active Cabinet (FAC) 5400

Installation Manual



Installing a Pre-Cast Concrete Pad

A concrete pad provides a permanent foundation to anchor the cabinet to the ground while protecting the cabinet from water damage and other outdoor surface conditions.

Install a pre-cast concrete pad for the cabinet at the installation site. Installation requires excavating the site, trenching cable conduit, creating a gravel foundation base, and installing the pre-cast pad using a crane or derrick.

Pre-cast pads typically ship configured with conduit entry cutouts and mounting fixtures (anchor studs or countersunk threaded inserts) for anchoring the cabinet to the pad. Specific features and dimensions vary by manufacturer. Contact your sales representative for a list of Clearfield-certified suppliers.

Pre-Cast Pad Requirements

When preparing for and installing a pre-cast concrete pad, observe the following guidelines. Refer to the pad drawings for guidance.

Guidelines

Follow these guidelines to ensure proper pad support for the cabinet. Adjust for local conditions or practices as required.

- Use a pad with a minimum height of 6 inches.
- Orient the pad with a maximum of 2 inches above-grade exposure.
- Use 4-inch maximum conduit for outside plant cables. See drawing below for entry locations.
- Use 2-inch maximum conduit for AC cable. See drawing below for entry location.
- Include pull cords in all cable conduits.

Refer to the pad manufacturer's instructions for additional guidelines.



FieldSmart® Fiber Active Cabinet (FAC) 5400

Installation Manual

Pad Drawings

Use the following drawings for reference during site preparation. Actual pad dimensions may vary by manufacturer. Refer to the manufacturer's documentation for more information.

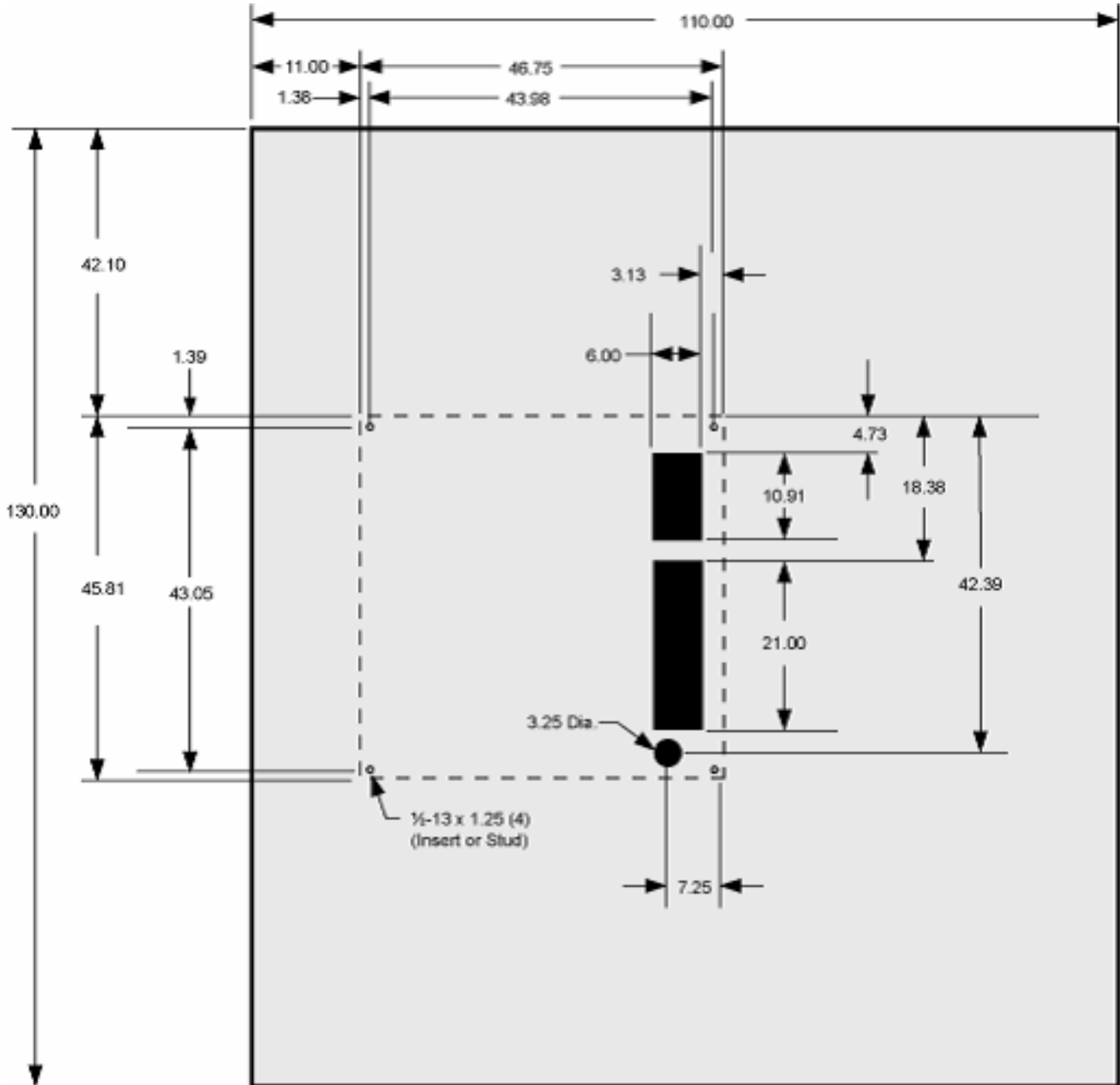

Typical Pad Size

FieldSmart® Fiber Active Cabinet (FAC) 5400

Installation Manual

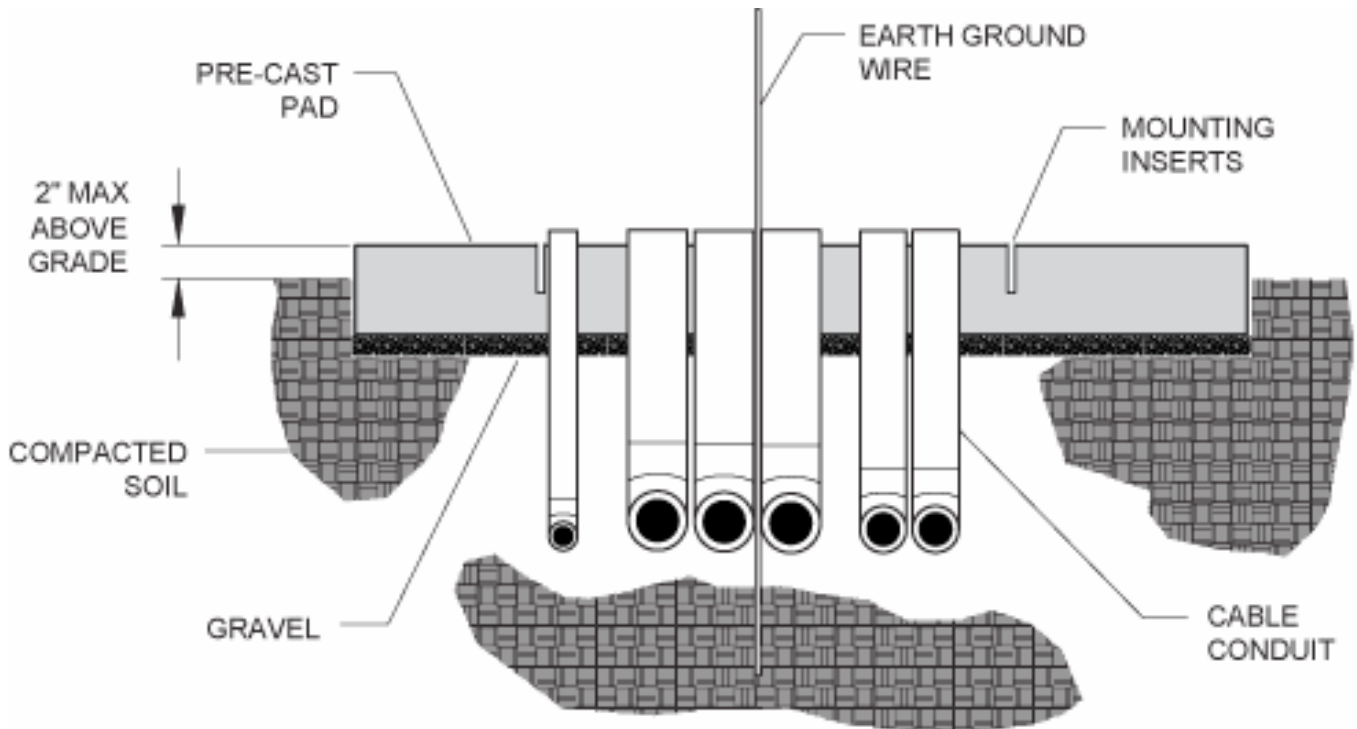

Pad Cross-Section

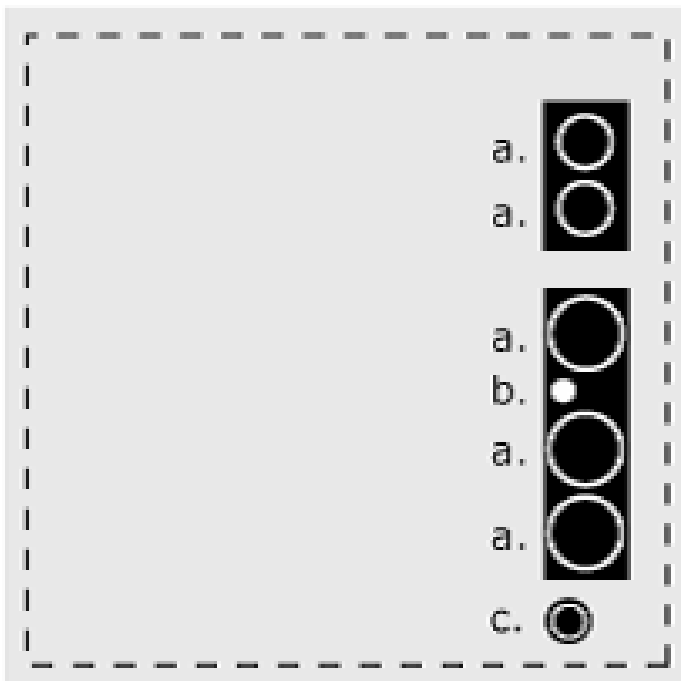

Conduit Locations

For proper cable entry into the cabinet, place conduit into the following locations.

- a. Conduit for outside plant cable.
- b. Earth ground wire (preferred location for direct connection to cabinet ground bar).
- c. Conduit for AC cable.



FieldSmart® Fiber Active Cabinet (FAC) 5400

Installation Manual

Preparing the Site

Prepare the site for installation of a pre-cast pad. Some pads may require custom preparations. Refer to the manufacturer's instructions for more information.

A general practice is described below for reference. Adapt the instructions as needed for local requirements, practices, or conditions.



DANGER! Do not place outside plant cables at the pad site before installing the pre-cast pad. Attempting to install a pre-cast pad over existing cables becomes hazardous if a person must reach underneath the lowered pad to feed cables through its entry cutout.

To prepare the site for pad installation

- Step 1:** Excavate the pad area. Dig a foundation hole six inches deep with a perimeter measuring at least 110 x 130 inches.
- Step 2:** Grade and compact the excavated surface until it is firm and level.
- Step 3:** Trench out conduit paths through the foundation hole (from the cable feeder location). Refer to the pad drawings for conduit locations.
- Step 4:** Place the cable conduits into the conduit trench. Refer to the pad construction guidelines for conduit sizes and locations.
- Step 5:** Route the earth ground wire through the conduit trench (from the ground electrode).
- Step 6:** Place gravel into the foundation hole to create a level base. The gravel layer should be at least two inches deep, compacted and leveled.

FieldSmart® Fiber Active Cabinet (FAC) 5400

Installation Manual



Installing a Pre-Cast Pad

Install the pre-cast pad according to the manufacturer's instructions (typically supplied with the pad).

A general installation practice is described below for reference. Adapt the instructions as needed for local requirements, practices, or conditions.



WARNING! The pre-cast concrete pad is extremely heavy. Handle with care to avoid personal injury or damage to the pad.

To install a pre-cast pad

- Step 1:** Transport the pre-cast pad to installation site.
- Step 2:** Using a crane and slings, lift the pad into position above the gravel base inside the foundation hole.
- Step 3:** Lower the pad onto the gravel base, allowing the conduits to pass through the cutout in the pad as it descends.
- Step 4:** Adjust the pad positioning on the gravel base until it is stable and level.
- Step 5:** Pull the earth ground wire through the cutout in the pad, allowing at least four feet of wire to extend above the top of the pad.
- Step 6:** Backfill and grade around the pad perimeter with soil to secure the pad in place.
- Step 7:** Verify that the pad remains level. Adjust as required.



FieldSmart® Fiber Active Cabinet (FAC) 5400

Installation Manual

Chapter 4: Installing the Cabinet

This chapter describes how to install the Clearfield FAC 5400 cabinet onto its permanent mounting location.

Topics Covered

This chapter covers the following topics:

- Unpacking the cabinet from its shipping crate.
- Operating the cabinet doors.
- Preparing the cabinet for installation.
- Installing the cabinet onto a concrete foundation pad.
- Replacing the cabinet lifting eye-bolts.

FieldSmart® Fiber Active Cabinet (FAC) 5400

Installation Manual



Unpacking the Cabinet

The cabinet ships from the factory on a wooden pallet and is enclosed in cardboard crating for protection. The cabinet is secured to the pallet by four bolts.

Do not remove the cabinet from the pallet until after it has been delivered to the installation site. However, you can remove the cardboard crating to inspect the cabinet at the staging area, if required. Clearfield recommends keeping the protective packaging in place for transportation.

When transporting the cabinet to the installation site, strap down the cabinet securely to the truck or trailer to prevent shifting or tipping. Unpack the cabinet at the installation site.

To unpack the cabinet

- Step 1:** After the cabinet has been delivered to the installation site, remove the cardboard packaging from the cabinet.
- Step 2:** Review the packing list to verify that all shipped materials are present.
- Step 3:** Discard the packaging material.
- Step 4:** Retrieve the telco hex key tied or taped to one of the cabinet doors.

Note: Use the supplied telco hex key to unlock the cabinet doors. See *Operating Cabinet Doors* for instructions.

Note: Do not remove the bolts securing the cabinet to the pallet until the cabinet is ready for placement.



FieldSmart® Fiber Active Cabinet (FAC) 5400

Installation Manual

Operating Cabinet Doors

Cabinet Doors

The cabinet is equipped with hinged doors on the front, rear, and splice compartments. Each door features a flush, tamper-proof handle with a telco hex-pin lock and padlock hasp for security. Open and close the compartment doors using the Clearfield-supplied telco hex key.

Each cabinet door is also equipped with an alarm switch that monitors the position of the door. When a door opens on a powered cabinet, an intrusion alarm reports through the equipment. You can pull the plunger on the switch to disable intrusion alarm reporting while working on the cabinet. The alarm switch is located at the upper corner of the door frame.

To open a cabinet door

- Step 1:** Insert the telco hex key into the hex-pin lock on the door handle.
- Step 2:** Turn the key counter-clockwise to disengage the door handle from the handle housing.

Note: When disengaged, the door handle pops forward as shown.



- Step 3:** Lift up on the handle to disengage the door latch.
- Step 4:** Swing the door open until the wind latch engages to brace the door open.
- Step 5:** When opening a door on a powered cabinet, pull the plunger on the alarm switch to disable reporting of the intrusion alarm.



Note: Do not rotate the switch plunger. Rotating the plunger may damage the switch.

FieldSmart® Fiber Active Cabinet (FAC) 5400

Installation Manual



To close a cabinet door

Step 1: Push up the wind latch to release the brace.



Step 2: Swing the door closed. Lift up on the handle and push the door against the cabinet.

Step 3: While holding the door firmly closed, push down on the handle to engage the door latch.

Step 4: Push the handle inward to engage it into the handle housing.

Battery Compartment Doors

The cabinet's front and rear battery compartments are equipped with removable access doors. Each battery compartment door is secured at the top by 7/16-inch hex bolts that can only be accessed when the cabinet door above it is open, thus preventing unauthorized access.

To open a battery compartment door

Step 1: Open the cabinet door above the battery compartment door.

Step 2: Using a 7/16-inch nut driver, remove the bolts at the top of the battery compartment door. Set aside the bolts to later re-attach the door.

Step 3: Tilt and pull the door panel forward, away from the cabinet.

Step 4: To completely remove the door, disconnect the ground strap using a 3/8-inch hex nut driver.

To close a battery compartment door

Step 1: Re-attach the ground strap to the door (if removed) using a 3/8-inch hex nut driver.

Step 2: Insert the tabs on the bottom of the door into the notches at the base of the compartment, then tilt and push the door panel closed. Some force may be required.

Step 3: Insert the bolts (removed previously) through the matching holes in the door and cabinet and tighten using a 7/16-inch nut driver.



FieldSmart® Fiber Active Cabinet (FAC) 5400

Installation Manual

Preparing the Cabinet for Installation

Complete the following pre-installation preparations before installing the cabinet.



ALERT! Isolation mat usage is mandatory for pad installations. Failure to use the isolation mat can accelerate cabinet corrosion and may void the Clearfield cabinet warranty.

To prepare the cabinet for installation

- Step 1:** Open the front, rear, and splice compartment doors.
- Step 2:** Open the front and rear battery compartment doors.
- Step 3:** In the splice compartment, remove the AC duct cover (two panels) as follows:
- Loosen (but do not remove) the mounting screws securing the duct cover panels to the fixture.
 - Slide the upper panel sideways to align its two keyholes with the two mounting screws. When aligned, pull the panel away from the fixture.
 - Slide the lower panel sideways to align its two keyholes with the two mounting screws. When aligned, pull the panel away from the fixture.
- Step 4:** From the battery compartment, remove the box containing the installation kit and set it aside for use during installation.
- Step 5:** From the rear compartment, remove the isolation mat and set it aside for use with concrete pad-mount installations.
- Note:** *The isolation mat is not required for wall/H-frame mounting installations.*
- Step 6:** Close the front and rear compartment doors. Leave the splice and battery compartment doors open.
- Step 7:** Remove the four bolts securing the cabinet to the pallet. The bolts are located at the bottom corners of the cabinet (two in the splice compartment, two in the battery compartment).



FieldSmart® Fiber Active Cabinet (FAC) 5400

Installation Manual



Installing the Cabinet on a Concrete Pad

The cabinet is equipped with four lifting eyebolts. Attach slings to the eyebolts to lift and move the cabinet with a boom crane or derrick. Position the boom crane or derrick truck near the installation site to perform this task.

The boom crane or derrick and the lifting slings must be capable of lifting at least a 2000 lb. working load. Use wire rope slings long enough to provide a minimum six foot vertical distance between the eyebolts and the sling junction to the boom line. Use appropriately rated connecting links or lifting hooks.

Clearfield recommends using at least three people to install the cabinet: one to operate the crane or derrick, one to guide the cabinet laterally as it lowers, and one to spot-check alignment of the mounting anchors/holes and the conduits/entry boxes as the cabinet lowers.



DANGER! The cabinet is very heavy. If it falls during lifting, it could cause death or serious injury to personnel. Do not stand under the load or place any part of your body under the load during lifting. Follow local safety practices for lifting and moving heavy loads.



CAUTION! Installing the cabinet requires safe handling to ensure that no injury to personnel or damage to the cabinet occurs.

Before installing the cabinet, verify that the splice compartment door is open to its locked position and that the battery compartment doors have been removed.

To install the cabinet on a concrete pad

- Step 1:** Sweep the pad free of dirt and debris.
- Step 2:** Install the isolation mat onto the concrete pad.
- Step 3:** Check the four lifting eyebolts on the top of the cabinet to ensure that they are securely seated.
- Step 4:** Attach the lifting slings to the boom line. Attach the other ends of the slings to the cabinet lifting eyebolts using connecting links or hooks.



FieldSmart® Fiber Active Cabinet (FAC) 5400

Installation Manual

Step 5: Lift the cabinet approximately 12 inches above the ground and position it directly above the foundation pad.



Step 6: Slowly lower the cabinet onto the pad, keeping the mounting holes in the cabinet base aligned with the anchor studs (or anchor holes) in the pad.

Note: *If properly aligned, the entry boxes in the splice compartment should slide down over the conduits protruding up from the pad as the cabinet lowers. If necessary, reach down through the entry boxes to grasp and align the top of the conduit to guide it through the entry box. Do not reach under the cabinet.*

Step 7: Pull the earth ground wire into the splice compartment through the center cable entry box.

Step 8: After the cabinet rests on the pad, disconnect the slings from the cabinet lifting eyebolts.

FieldSmart® Fiber Active Cabinet (FAC) 5400

Installation Manual



Step 9: Anchor the cabinet to the pad as follows:

- **Pads with anchor studs:**
 - a. Get the four hex nuts, four square washers, and four lock washers from the installation kit.
 - b. Install one square washer, lock washer, and hex nut onto each of the four anchor studs (two in the splice compartment, two in the battery compartment).
 - c. Tighten the hex nuts to secure the cabinet to the pad.
- **Pre-cast pads with threaded inserts:**
 - a. Get four anchor bolts, four square washers, and four lock washers from the pre-cast pad kit.
 - b. Install one square washer, lock washer, and anchor bolt into each of the four threaded mounting inserts (two in the splice compartment, two in the battery compartment).
 - c. Tighten the bolts to secure the cabinet to the pad.

Step 10: Verify that all cabinet doors open and close freely. If necessary, use shims to level the cabinet.

Step 11: Apply silicone caulking to the bottom perimeter of the cabinet.



FieldSmart® Fiber Active Cabinet (FAC) 5400

Installation Manual

Replacing the Lifting Eye Bolts

After the cabinet is securely mounted, seal the roof by replacing the lifting eyebolts with button-head Allen bolts from the installation kit.

Note: The four bolts on the cabinet roof secure the roof assembly to the cabinet. When replacing the eyebolts, remove and replace each bolt in sequence. Do not remove all bolts at the same time.



CAUTION! Replace the eyebolts one at a time to ensure that the roof is securely attached to the cabinet at all times.

To replace the lifting eyebolts

Step 1: Using a screwdriver, unscrew and remove a lifting eyebolt from the top of the cabinet.



Step 2: Using the Clearfield-supplied telco hex key, install a button-head Allen bolt into the vacant bolt hole.



Step 3: Repeat Steps 1 and 2 to replace each additional lifting eyebolt on the cabinet roof, one at a time.

FieldSmart® Fiber Active Cabinet (FAC) 5400

Installation Manual



Chapter 5: Installing Power

This chapter describes how to install a commercial AC power supply to the cabinet.

Topics Covered

This chapter covers the following topics:

- Installing the cabinet ground connection.
- Installing the AC power supply (220–240 VAC standard).
- Installing the AC power supply (110–120 VAC option).



FieldSmart® Fiber Active Cabinet (FAC) 5400

Installation Manual

Installing the Cabinet Ground Connection

The cabinet's connection to the earth ground circuit must be in place before you install power to the cabinet.

To install the cabinet ground connection

- Step 1:** Open the splice compartment door.
- Step 2:** Route the earth ground wire to the main ground bar (located at the bottom of the compartment) and cut the wire to length.
- Step 3:** Using a crimp tool, attach a two-hole compression lug (#2 AWG, 3/4-inch hole spacing) to the earth ground wire.
- Step 4:** At the middle of the ground bar, locate a ground position with 3/4-inch stud spacing. Remove the nuts from the identified terminal studs.
- Step 5:** Attach the earth ground wire's two-hole lug onto the 3/4-inch ground terminal studs.

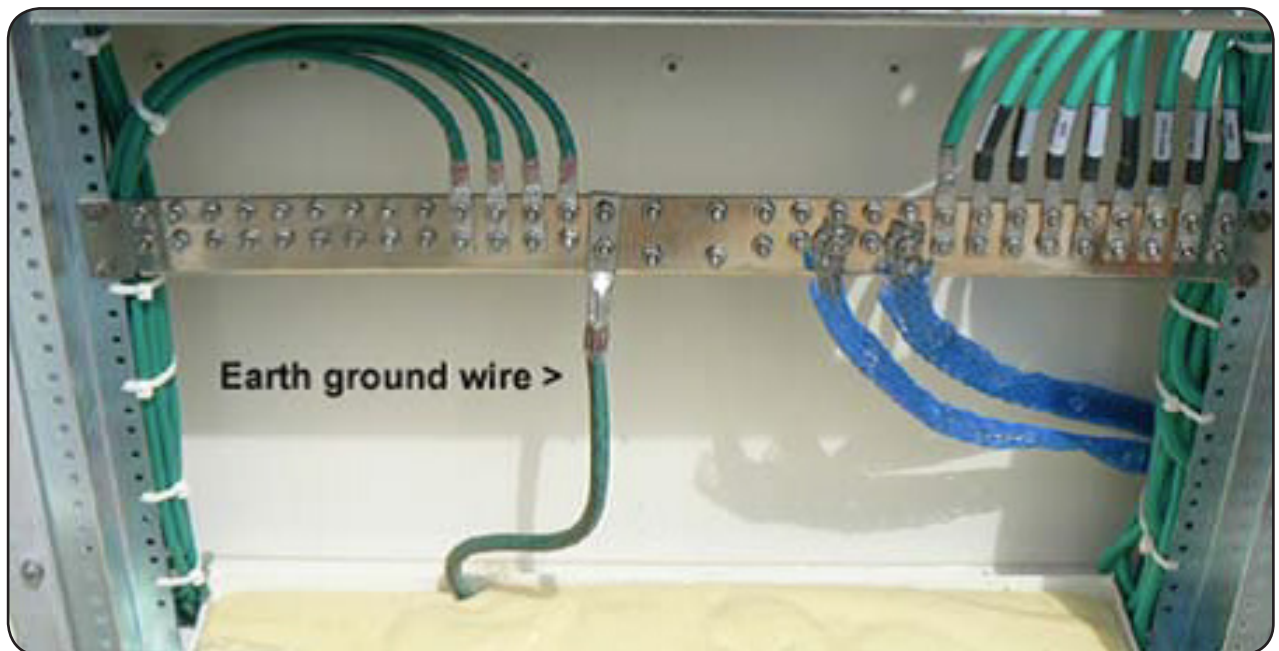

- Step 6:** Re-connect the nuts to the ground terminal studs and tighten to 26 inch-lbs. of torque.

FieldSmart® Fiber Active Cabinet (FAC) 5400

Installation Manual



Installing AC Power (220-240 VAC)

Note: The cabinet ships from the factory equipped to support 220-240 VAC service. However, the cabinet AC load center can be reconfigured to support 110-120 VAC service if required. See *Installing AC Power (110-120 VAC)* for details.

Install 220-240 VAC power as described below.



DANGER! High voltage may be present. Do not apply AC power to the cabinet until the installation process is complete.



WARNING! Electrical hazard. Only a qualified electrician should perform this procedure.

Before proceeding, verify that AC service to the cabinet site is OFF at the local power transfer switch.

To install AC power (220-240 VAC)

- Step 1:** Open the splice compartment door.
- Step 2:** At the cabinet AC load center, switch all breakers to the **OFF** position.
- Step 3:** Remove the left cover panel from the AC load center.
- Step 4:** Remove the AC duct cover (two panels) as follows:
- Loosen (but do not remove) the mounting screws securing the duct cover panels to the fixture.
 - Slide the upper panel sideways to align its two keyholes with the two mounting screws. When aligned, pull the panel away from the fixture.
 - Slide the lower panel sideways to align its two keyholes with the two mounting screws. When aligned, pull the panel away from the fixture.
- Step 5:** Pull the AC cable into the cabinet through the entry hole in the base of the compartment.
- Step 6:** Route the AC cable up through the duct and feed it into a hole on the left side of the AC load center.
- Step 7:** Remove the Main Service Disconnect breaker from the load center housing to ease wire termination. Pull the breaker straight out to disengage it from the assembly.



CLEARFIELD

Step 8:

Connect the AC wiring as follows:

- Connect the green (ground) lead to the ground bus bar.
- Connect the white (neutral) lead to the neutral bar.
- Connect the black L1 lead to the left side of the Main Service Disconnect breaker.
- Connect the red L2 lead to the right side of the Main Service Disconnect breaker.

Step 9: Re-attach the Main Service Disconnect breaker into the load center.

Step 10: Dress and secure the AC cable, providing adequate strain relief.

Step 11: Replace the AC duct cover (two panels) and the left cover panel on the AC load center.

Installing AC Power (110-120 VAC)

The cabinet ships from the factory equipped to support 220-240 VAC service, but can be reconfigured to support 110-120 VAC service if required. Converting the AC load center to support 110-120 VAC input requires modification to existing wiring.

The 110-120 VAC input power option is only supported in conjunction with use of 20 Amp rectifier modules.

Note: When supplied by 110-120 VAC input power, the cabinet supports a maximum load of 2160 Watts. If your application requires a load that exceeds 2160 Watts, use a 220-240 VAC input power supply instead.



DANGER! High voltage may be present. Do not apply AC power to the cabinet until the installation process is complete.



WARNING! Electrical hazard. Only a qualified electrician should perform this procedure.

Before proceeding, verify that AC service to the cabinet site is OFF at the local power transfer switch.

To reconfigure the AC load center for 110-120 VAC service

Step 1: Open the splice compartment door.

Step 2: At the cabinet AC load center, switch all breakers to the OFF position.

Step 3: Remove the left cover panel from the AC load center.

Step 4: Using a slot head screwdriver, loosen the two terminal screws at the bottom of the Main Service Disconnect breaker.

Step 5: Install a 12 AWG wire jumper (3.5 inch length) between the two terminal screws (L1, L2) of the Main Service Disconnect breaker.

FieldSmart® Fiber Active Cabinet (FAC) 5400

Installation Manual



- Step 6:** For cabinets equipped with a generator connector, perform these additional steps:
- a. Remove the right cover panel from the AC load center.
 - b. Disconnect the L2 wire from the Gen Conn breaker. Remove the other end of the L2 wire (red) from the back of the generator connector plug.
 - c. Install a 12 AWG wire jumper (3.5 inch length) between the L1 and L2 terminal screws on the Gen Conn breaker.
 - d. Disconnect the white leads from the Rectifier A and Rectifier B breakers, then connect the white leads to the neutral bar.
 - e. Replace the right cover panel on the AC load center.

To install AC power (110-120 VAC)

- Step 1:** Verify that all AC load center breakers are in the **OFF** position.
- Step 2:** Remove the AC duct cover (two panels) as follows:
- a. Loosen (but do not remove) the mounting screws securing the duct cover panels to the fixture.
 - b. Slide the upper panel sideways to align its two keyholes with the two mounting screws. When aligned, pull the panel away from the fixture.
 - c. Slide the lower panel sideways to align its two keyholes with the two mounting screws. When aligned, pull the panel away from the fixture.
- Step 3:** Pull the AC cable into the cabinet through the entry hole in the base of the compartment.
- Step 4:** Route the AC cable up through the duct and feed it into a hole on the left side of the AC load center.
- Step 5:** Remove the Main Service Disconnect breaker from the load center housing to ease wire termination. Pull the breaker straight out to disengage it from the assembly.
- Step 6:** Connect the AC wiring as follows:
- Connect the green (ground) lead to the ground bus bar.
 - Connect the white (neutral) lead to the neutral bar.
 - Connect the L1 lead to the left side of the Main Service Disconnect breaker.
- Step 7:** Re-attach the Main Service Disconnect breaker into the load center.
- Step 8:** Dress and secure the AC cable, providing adequate strain relief.
- Step 9:** Replace the AC duct cover (two panels) and the left cover panel on the AC load center.



FieldSmart® Fiber Active Cabinet (FAC) 5400

Installation Manual

Chapter 6: Installing and Splicing Outside Plant Cables

This chapter describes how to install and splice outside plant cables into the cabinet, including metallic plant (copper twisted pairs for subscriber drops and/or transport) and fiber plant (fiber-optic cables for transport and/or PON subscriber drops).

Topics Covered

This chapter covers the following topics:

- Installing metallic cables.
- Installing fiber cables.
- Sealing cable entry locations.

FieldSmart® Fiber Active Cabinet (FAC) 5400

Installation Manual



Installing Metallic Cables

This section describes how to install metallic signal cables into the cabinet, including how to route, secure, and groom the outside plant cables and how to splice the metallic pairs to the equipment cables.

Installing Metallic Outside Plant Cables

Install metallic outside plant (OSP) cables into the cabinet and prepare the cables for splicing. The following steps are general guidelines only. Follow local practice where applicable.

To install metallic outside plant cables

- Step 1:** Open the cabinet's splice compartment door to its locked position.
- Step 2:** Route the metallic OSP cables through the underground conduits and up into the cabinet.
- Step 3:** Pull approximately six feet of each cable up into the splice compartment through the cable entry duct.
- Step 4:** Using ropes or cable ties, temporarily hang and secure the OSP cables inside the splice compartment.
- Step 5:** If splicing shall be performed at a later date, make sure the cables fit inside the splice compartment with the door closed. Take care to not violate the cable bend radius requirements.

The following steps are general guidelines only. Follow local practice where applicable.

To prepare outside plant cables for splicing

- Step 1:** Untie the ropes or cut the cable ties temporarily securing the OSP cables inside the splice compartment.
- Step 2:** Strip off the cable's outer sheath and internal metal shielding down to 12 inches above where the cable enters the cabinet. Take care to expose, but not penetrate, the core wrap surrounding the bundled copper pairs.
- Step 3:** Ground the OSP cable sheath to the cabinet ground bar as follows:
 - a. Install a B-bond clamp onto the cut end of the OSP cable's outer sheath. Wrap the connection with electrical tape.
 - b. Attach a #6 AWG bond strap to the B-bond clamp.

- c. Terminate the other end of the bond strap to the main ground bar at the bottom of the splice compartment.

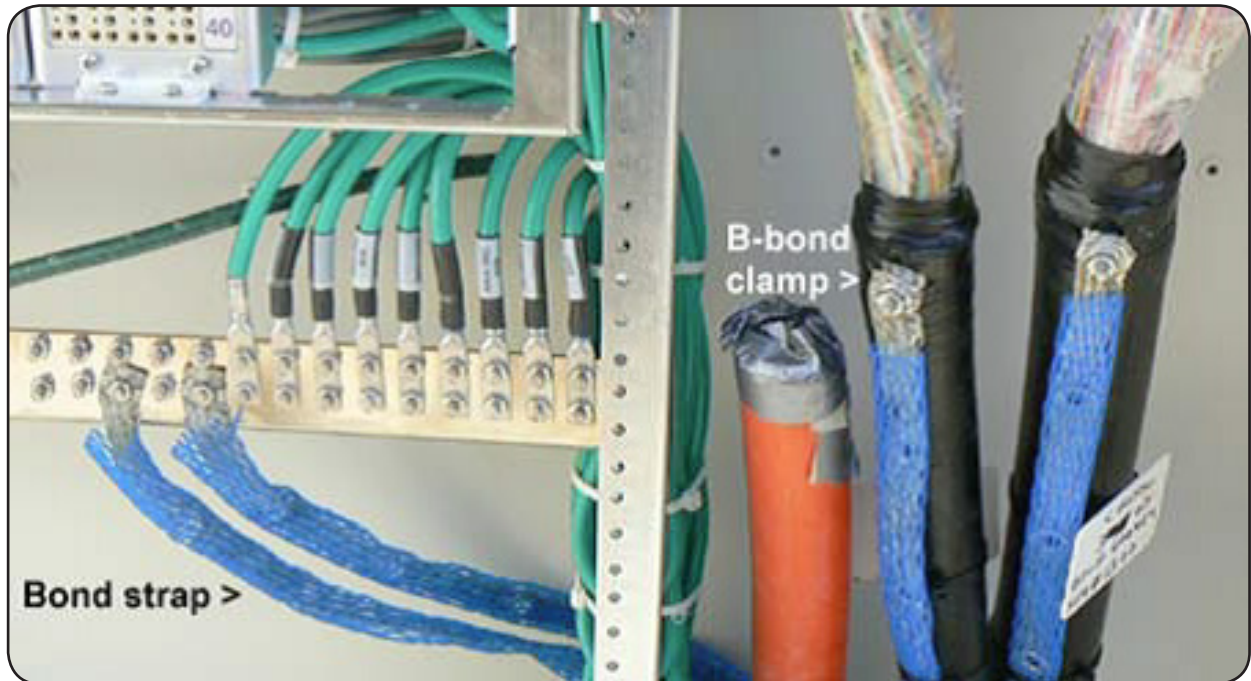

- Step 4:** Secure the OSP cable to the rack or tie bars with cable ties.
- Step 5:** Remove the core wrap from around the bundled copper pairs, down to 18 inches above the cut end of the outer sheath, then install binder group identification labels on each 25-pair group.
- Step 6:** Repeat Steps 1 through 5 for each remaining OSP cable.
- Step 7:** If splicing shall be performed at a later date, make sure the cables fit inside the splice compartment with the door closed. Take care to not violate the cable bend radius requirements.

FieldSmart® Fiber Active Cabinet (FAC) 5400

Installation Manual



Splicing Metallic Cables

For mating outside plant (OSP) cables to equipment cables, the FAC 5400 supports MS2 or 710 connector options for the protection block cables and MS2 connectors for cross-connect panel cables.

The equipment cables are factory terminated with MS2 or 710 connectors and are secured to tie bars in the splice compartment. Counterpart MS2 or 710 connectors must be installed on each 25-pair group from the OSP cables.

The modular design of the FAC 5400 copper line protection system allows you to incrementally expand line capacity in the field. If you require additional copper protection capacity before splicing cables, you can install an additional protection panel mounting frame and/or additional protection blocks to expand capacity. See *Installing a Protection Mounting Frame* and *Installing a Protection Block* for instructions.

To splice the metallic cables

- Step 1:** Open the cabinet's splice compartment door to its locked position.
- Step 2:** Segregate the bundled pairs from the OSP cable into 25-pair groups.
- Step 3:** Terminate MS2 or 710 connectors onto the ends of each 25-pair group per local practice.
- Step 4:** Remove all cable ties securing the cabinet equipment cables to tie bars and remove the protective covers from the connectors.
- Step 5:** For each 25-pair group, mate the OSP and equipment connectors together using the appropriate MS2 or 710 connector mating clamps.
- Step 6:** Repeat Steps 2 through 5 for each remaining OSP cable.
- Step 7:** Dress and secure the spliced cables to the rack or tie bars with cable ties.



FieldSmart® Fiber Active Cabinet (FAC) 5400

Installation Manual

Installing 5-Pin Protection Modules

To complete the wiring connection between the metallic outside plant cables and cabinet equipment cables, you must install 5-pin protection modules into the protection blocks to protect the copper lines from electrical surges.

Each protection block protects 48 pairs with each 5-pin position on the block protecting one wire pair (one 2-wire circuit or half of a 4-wire circuit). Install a 5-pin protection module into each position on the protection block that shall be equipped for service. Use black modules for T0 circuits and red modules for T1 circuits. Refer to the cabinet pair assignment list for more information.

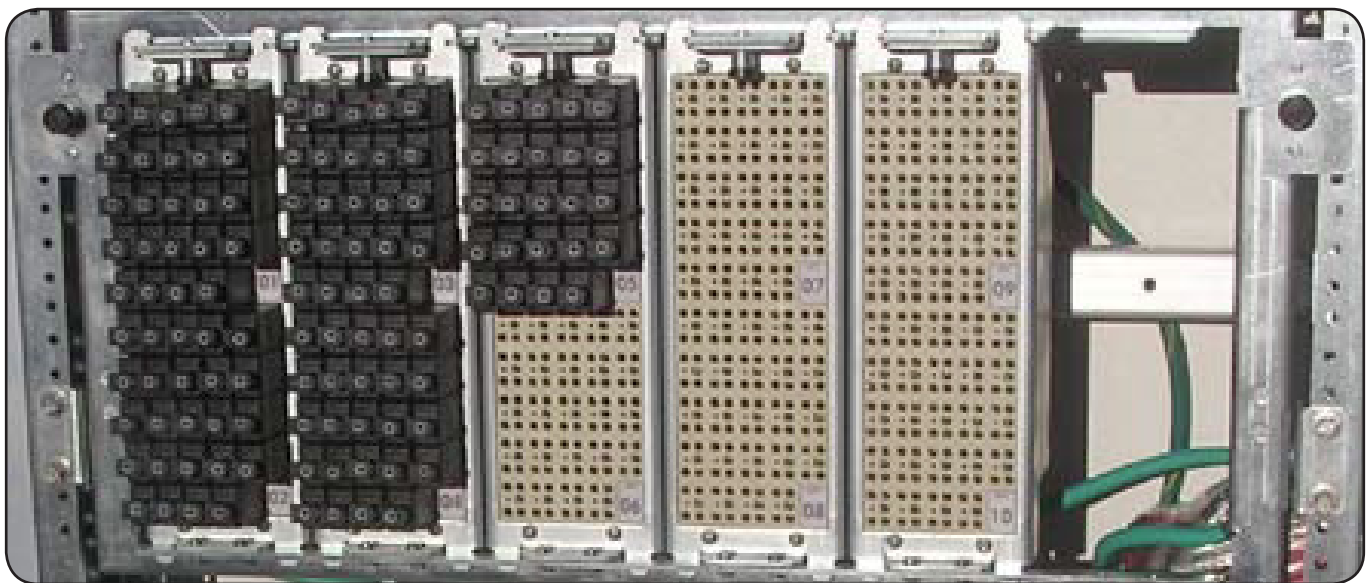

FieldSmart® Fiber Active Cabinet (FAC) 5400

Installation Manual



Installing Fiber Cables

This section describes how to install fiber optic cables into the cabinet, including how to route and groom the outside plant cables and splice optical fibers to the distribution systems.

Fiber management guidelines

When installing, splicing, and routing fibers in the cabinet, follow these guidelines:

- Avoid tight bend radii for fibers and provide adequate strain relief.
- Dress and secure fiber jumpers using velcro straps or other soft-tie method designed for fiber. Do not use plastic cable ties, which can damage a fiber.
- Label jumpers to simplify identification at splice and distribution locations.

Installing Fiber Outside Plant Cables

Install fiber optic outside plant (OSP) cables into the cabinet and prepare the cables for splicing. The following steps are general guidelines only. Follow local practice wherever applicable.

To install fiber outside plant cables

- Step 1:** Open the cabinet's splice compartment door to its locked position.
- Step 2:** Route the fiber OSP cables through the underground conduits and up into the cabinet.
- Step 3:** Pull each cable up into the splice compartment through the cable entry duct. Pull enough cable length to accommodate the fiber routing/splicing scheme that shall be used.
- Step 4:** Using ropes or cable ties, temporarily hang and secure the OSP cables inside the splice compartment.
- Step 5:** If splicing shall be performed at a later date, make sure the OSP cables fit inside the splice compartment with the door closed. Take care to not violate the cable bend radius requirements.



FieldSmart[®] Fiber Active Cabinet (FAC) 5400

Installation Manual

The following steps are general guidelines only. Follow local practice where applicable.

To prepare outside plant cables for splicing

- Step 1:** Untie the ropes or cut the cable ties temporarily securing the OSP cables inside the splice compartment.
- Step 2:** Strip off approximately six feet of the cable's outer sheath to expose the core tubing. Take care not to damage the fibers inside the core tubing.
- Step 3:** Ground the OSP cable sheath to the cabinet ground bar as follows:
- Twist the OSP cable's metal strength members together into a single strand.
 - Install a lug connector on the twisted end of the strength members.
 - Install a #6 AWG bond strap onto the lug connector together with the twisted strength members and tighten the lug connector.
 - Terminate the other end of the bond strap to the main ground bar, located near the bottom of the splice compartment.

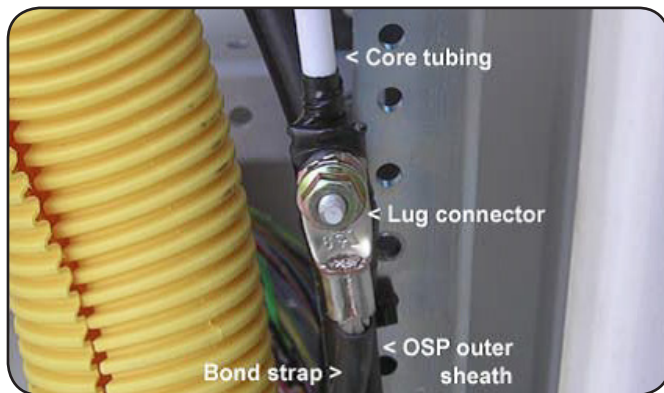

- Step 4:** Strip off the core tubing down to an appropriate length above the cut end of the outer sheath. Take care not to sever or nick the bare fibers. If you are using a splice tray, route the core tubing to the splice tray before stripping it to provide sufficient length.
- Step 5:** Thoroughly clean all bare fibers, then insert the fibers into a length of clear PVC unit tubing for routing to the splice location. Attach the lower end of the PVC unit tubing to the OSP cable with electrical tape.
- Step 6:** Mount and secure the OSP cable's outer sheath to the rack or tie bars with cable ties.
- Step 7:** Repeat Steps 1 through 6 for each remaining OSP cable, if present.
- Step 8:** If splicing shall be performed at a later date, coil up and temporarily secure the unit tubing to the rack with cable ties.

FieldSmart® Fiber Active Cabinet (FAC) 5400

Installation Manual



Splicing Fiber Cables

Common methods for splicing outside plant fibers to optical equipment include:

- **Pigtail splicing:** Outside plant fibers are spliced to connectorized pigtails that plug into a distribution panel, where they mate with fiber jumpers that connect to the equipment. This method provides flexibility, where the distribution panel serves as an adapter/patch panel for equipment with different connector types.
- **Jumper splicing:** Outside plant fibers are spliced directly to fiber jumpers that connect to the optical equipment, bypassing any intermediate adapter/patch panels.

Both the pigtail and jumper splicing methods typically use fiber splice trays to hold the individual fiber splices. Clearfield offers field-installed splice trays with fusion, mechanical, and heat shrink splicing options. Each fiber splice tray can hold up to 12 fiber splices. See *Installing a Fiber Splice Tray Holder* for installation instructions.



DANGER! CLASS 1 LASER PRODUCT. INVISIBLE LASER RADIATION PRESENT. Fiber optic radiation can cause severe eye damage or blindness. Do not look into the open end of an optical fiber.



CAUTION! Only a qualified technician should perform this procedure.

To splice fiber cables

- Step 1:** Open the cabinet's splice compartment door.
- Step 2:** Locate the unit tubing that contains the bare OSP fibers. The unit tubing, which protects the fibers for routing, is typically secured to the rack. Remove the cables ties if present.
- Step 3:** Route the fibers to the splice tray as follows:
- If the splice tray is located in the splice compartment, hang the unit tubing on the splice tray holder bracket.
 - If the splice tray is located in the front or rear compartment:
 - a. Insert the unit tubing into the fiber routing duct and feed the tubing through the duct into front or rear compartment.
 - b. Hang the unit tubing on the splice tray holder bracket.
- Step 4:** Trim the unit tubing down to expose enough bare fiber to perform splicing, plus excess fiber for slack storage in the splice tray.
- Step 5:** Splice the outside plant fibers to the fiber pigtails or jumpers per local practice.
- Step 6:** Place the splices and slack fiber into a splice tray as shown.
- Step 7:** Insert the fiber splice tray into the splice tray holder and secure the tray in place using a supplied Velcro strap.

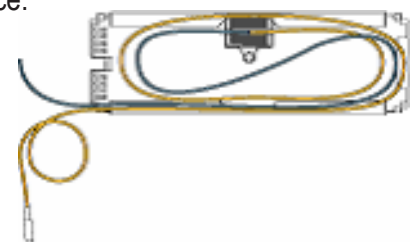



FieldSmart® Fiber Active Cabinet (FAC) 5400

Installation Manual

Routing and Terminating Fibers

Route fibers from the splice location to the termination location. The termination equipment and location may vary by configuration:

- With the pigtail splicing method, you typically route the pigtails from the splice tray to a distribution panel and plug the pigtail connectors into the panel. You can then use fiber jumpers to connect to the optical equipment from the distribution panel.
- With the jumper splicing method, you typically route the fiber jumpers from the splice tray directly to the optical equipment. No intermediate patch panel is typically used.

Route and terminate fibers per your application requirements and local practice. Clearfield offers field-installed fiber distribution systems that mount in an available 23-inch rack space. Options include a 1 RU fiber distribution panel with 12 or 24 positions, or a 6 RU fiber distribution cassette holder that holds up to six cassettes, each with 12 positions. Adapters are available with SC, FC, LC, or ST connector options. See *Installing a Fiber Distribution Panel* or *Installing a Fiber Distribution Cassette Holder* for installation instructions.



DANGER! CLASS 1 LASER PRODUCT. INVISIBLE LASER RADIATION PRESENT. Fiber optic radiation can cause severe eye damage or blindness. Do not look into the open end of an optical fiber.

To route and terminate fibers to equipment

Step 1: At the fiber splice tray, locate the fibers (pigtails or jumpers) to route and terminate.

Step 2: Route the fibers to the termination point as follows:

- If the splice tray is located in the splice compartment, insert the fiber pigtails or jumpers into the fiber routing duct and feed them into the front or rear compartment. Route the fiber pigtails or jumpers to the termination point and temporarily drape on the equipment.
- If the splice tray is located in the front or rear compartment, route the fiber pigtails or jumpers to the termination point and temporarily drape on the equipment.

Step 3: Terminate the fibers using one of the following methods:

- **Direct connection:** Connect the fiber jumpers to the connectors on the optical equipment.
- **Fiber distribution panel:** Connect the fiber pigtails to the adapter plugs on the back side of the distribution panel.
- **Fiber distribution cassette:**
 - a. Open the cassette and connect the fiber pigtails to the adapter plugs on the inside of the cassette.
 - b. Coil the slack fiber inside, then close the cassette.
 - c. Slide the cassette into any available position in the cassette holder (hook side down), and fold the cassette holder back flush against the bracket.

FieldSmart® Fiber Active Cabinet (FAC) 5400

Installation Manual



- Step 4:** If necessary, neatly coil any excess slack fiber into an arrangement that won't interfere with or become snagged on the equipment.
- Step 5:** Dress and secure the routed fibers to the rack with Velcro straps.

Sealing Cable Entry Locations

The installation kit includes a sealant compound that you can apply to the cable entry locations to seal the cabinet against moisture, dust, pests, and other contaminants.



ALERT! The sealant package does not require tools to open or mix the compound. Do not insert tools into the plastic nozzle or pierce the sealant package.

To seal the cable entry locations

- Step 1:** Get the package of sealant compound from the installation kit.
- Step 2:** Mix the sealant compound inside its package per the manufacturer instructions printed on the package.
- Step 3:** Open the cabinet's splice compartment door.
- Step 4:** Apply the sealant around open areas in the entry ducts where the cables/conduit enter the cabinet. Seal all gaps around the cables. Follow the manufacturer's instructions to apply the sealant.



CAUTION! Check to ensure that all gaps are completely sealed. Gaps allow penetration of moisture, insects, rodents, and other contaminants that could damage equipment.



FieldSmart[®] Fiber Active Cabinet (FAC) 5400

Installation Manual

Chapter 7: Turning Up the Cabinet Power System

This chapter describes how to turn up and test the cabinet power system, including checking the AC power supply voltage, installing rectifier modules into the optional Valere power shelf, installing batteries for reserve power, and turning up and testing the DC power system.

Topics Covered

This chapter covers the following topics:

- Checking the cabinet ground connection.
- Checking the AC power supply voltage.
- Installing rectifier modules into the optional Valere power shelf.
- Installing batteries for reserve power.
- Turning up and testing the DC power system.

FieldSmart® Fiber Active Cabinet (FAC) 5400

Installation Manual



Checking the Ground Connection

Check the impedance of the cabinet ground connection as follows.

Note: The following procedure does not test the quality of the earth ground circuit (earth electrode), which should have been installed and tested before the cabinet was installed.

To check the cabinet ground connection

- Step 1:** Using an ohm meter, test between the main ground bar and the earth ground wire:
- Place one lead on the main cabinet ground bar (located at the bottom of the splice compartment).
 - Place the other lead on the earth ground wire.
- Step 2:** Verify that the ohm meter reads 5 ohms or less.
- Step 3:** If the reading is greater than 5 ohms, check the ground wire connection at the main ground bar, then retest.

Checking the AC Power Supply Voltage

The cabinet ships from the factory equipped to support 220-240 VAC service. Check the AC power supply voltage as follows.



DANGER! High voltage may be present. Only a qualified electrician should perform these procedures.

To check 220-240 VAC power supply voltage

- Step 1:** Apply AC power to the cabinet at the local power transfer switch.
- Step 2:** At the cabinet AC load center, do the following:
- Remove the left and right cover panels from the AC load center.
 - Switch the 60A Main Service Disconnect breaker to **ON**.
 - Switch the 60A Main breaker to **ON**.



FieldSmart[®] Fiber Active Cabinet (FAC) 5400

Installation Manual

Step 3: Using a volt meter, test between the L1 and neutral busses:

- a. Place one lead on the L1 buss.
- b. Place the other lead on the neutral buss.
- c. Verify that the volt meter reads between 110 and 120 VAC.

Step 4: Using a volt meter, test between the L2 and neutral busses:

- a. Place one lead on the L2 buss.
- b. Place the other lead on the neutral buss.
- c. Verify that the volt meter reads between 110 and 120 VAC

Step 5: Using a volt meter, test between the L1 and L2 busses.

- a. Place one lead on the L1 buss.
- b. Place the other lead on the L2 buss.
- c. Verify that the volt meter reads between 220 and 240 VAC.

Step 6: Switch the 15A Heater and Conv. Outlet breakers to **ON**.

Note: Do not switch the Rectifier A and Rectifier B breakers on at this time.

Step 7: Re-attach the left and right cover panels on the AC load center.

FieldSmart® Fiber Active Cabinet (FAC) 5400

Installation Manual



To support 110-120 VAC service, the cabinet AC load center must be re-configured in the field. See Installing AC Power (110-120 VAC) for details. If the cabinet is equipped for 110-120 VAC service, test the AC power supply voltage as follows.

To check 110-120 VAC power supply voltage

Step 1: Apply AC power to the cabinet at the local power transfer switch.

Step 2: At the cabinet AC load center, do the following:

- a. Remove the left and right cover panels from the AC load center.
- b. Switch the 60A Main Service Disconnect breaker to **ON**.
- c. Switch the 60A Main breaker to **ON**.

Step 3: Using a volt meter, test between the L1 and neutral busses:

- a. Place one lead on the L1 buss.
- b. Place the other lead on the neutral buss.
- c. Verify that the volt meter reads between 110 and 120 VAC.

Step 4: Using a volt meter, test between the L2 and neutral busses:

- a. Place one lead on the L2 buss.
- b. Place the other lead on the neutral buss.
- c. Verify that the volt meter reads between 110 and 120 VAC

Step 5: Switch the 15A Heater and Conv. Outlet breakers to **ON**.

Note: Do not switch on the Rectifier A and Rectifier B breakers at this time.

Step 6: Re-attach the left and right cover panels on the AC load center.



FieldSmart® Fiber Active Cabinet (FAC) 5400

Installation Manual

Installing Rectifier Modules into the optional Valere Power Shelf

The FAC 5400 cabinet can be outfitted with an optional Valere compact power system to generate and distribute -48 VDC bulk power. The Valere power system consists of a 19-inch G-series power shelf and a 23-inch DC distribution shelf.



The Valere power shelf supports up to four rectifier modules (30A or 20A options). Normal operation for the FAC 5400 cabinet requires a minimum of two rectifier modules. Use up to two additional rectifier modules to provide module redundancy, faster battery charging time, or powering for third-party equipment. Each Valere power shelf is equipped with a controller module that monitors power functions and alarm information and regulates voltage in response to battery temperature. The controller module features a 16-character front panel display for programming menu-driven system controls. For a complete description of the Valere power shelf, refer to the Valere Compact DC Power System Installation and Maintenance manual.

The Valere DC distribution shelf provides distribution of -48 VDC power to equipment and batteries. The distribution shelf is equipped with 20 GMT fuse positions, and two battery breaker positions. The typical configuration for an FAC 5400 cabinet includes two 30A load breakers, two 40A battery breakers, and two 5A GMT fuses (heat exchangers). For a complete description of the Valere DC distribution shelf, refer to the Valere DC Distribution Panel manual.

FieldSmart® Fiber Active Cabinet (FAC) 5400

Installation Manual



Install Valere modules into the power shelves as described below.

To install a controller module

- Step 1:** Unpack the controller module.
- Step 2:** If the face plate is attached to the controller module, disconnect its display cable from the controller module.
- Step 3:** Insert the controller module halfway into the control slot on the Valere shelf.
- Step 4:** Connect signal cables to the controller module as follows:
 - a. Connect the alarm (ALM), temperature probe (T3), and expansion (EXP) cables to the controller module.
 - b. Connect the face plate's display cable (Display) to the controller module. Allow the face plate to dangle.
- Step 5:** Push firmly on the module to seat it in the slot, then tighten the set screw.
- Step 6:** Attach the face plate to the controller module.

To install a rectifier module

- Step 1:** Unpack the rectifier module.
- Step 2:** On the lower left of the module face plate, press the tab to release the ejector lever.
- Step 3:** Insert the rectifier module into an empty slot in the Valere shelf. Slots are typically populated from left to right.
- Step 4:** Push firmly on the module to seat it in the slot.
- Step 5:** Push the ejector lever closed to secure the module in place.
- Step 6:** Repeat Steps 1–5 to install additional rectifier modules.

Note: Refer to the *Valere Compact DC Power System Installation and Maintenance* manual for more information.



FieldSmart® Fiber Active Cabinet (FAC) 5400

Installation Manual

Installing Batteries

The FAC 5400 cabinet can house up to two strings of front terminal batteries (four batteries per string). See *Supported Batteries* for a list of supported battery types.



WARNING! Electrical hazard. Batteries contain a stored charge. Only a qualified technician should perform this procedure.



CAUTION! Electrical, chemical, fire, and heat hazard. Handle batteries with care to avoid personal injury or damage to the equipment.



ALERT! Read the battery manufacturer's instructions before installing batteries. Follow the manufacturer guidelines and local safety practices.

To prepare batteries for installation

- Step 1:** Unpack the batteries from the shipping packaging.
- Step 2:** Remove the terminal caps from the top of each battery.
- Step 3:** Clean and apply No-Ox anti-corrosion grease to each battery terminal.
- Step 4:** Locate the bagged kit containing the string jumper straps and other materials. Set the kit aside for use during installation.

Note: If you are using an optional battery heater, install the heater before installing batteries. See *Installing a Battery Heater for instructions*.



WARNING! In -48V telecom systems, red leads connect to the negative terminal and black leads connect to the positive terminal. Do not reverse the wiring polarities.

FieldSmart® Fiber Active Cabinet (FAC) 5400

Installation Manual



To install batteries

- Step 1:** At the DC distribution panel, verify that the battery breakers are **OFF**.
- Step 2:** Remove the front and rear battery compartment doors. See *Operating Cabinet Doors*) for instructions.
- Step 3:** In the battery compartment, disconnect the three pairs of #10 AWG battery power cables (with Anderson connectors) from the power supply leads. Set the cables aside.
- Step 4:** Place up to three battery strings into the battery compartment, arranged as shown.

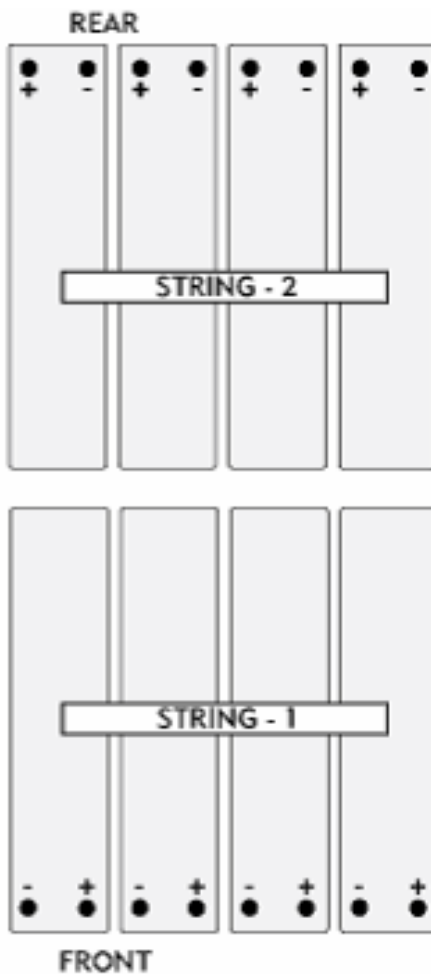

- Step 5:** Install the jumper straps between the terminal posts of the batteries in each string per the manufacturer instructions.
- Step 6:** If you are using three battery strings, install the #10 AWG white jumper cable between the two middle batteries of String 3 as shown below.

- Step 7:** For each battery string, connect the battery power cables as follows:
- Remove the protective rubber caps from the cable ring lugs.
 - Attach the black cable to the positive (+) terminal post at the positive end of the string.
 - Attach the red cable to the negative (-) terminal post at the negative end of the string.
 - Tighten the nuts on the terminal posts to the torque specified by the manufacturer.

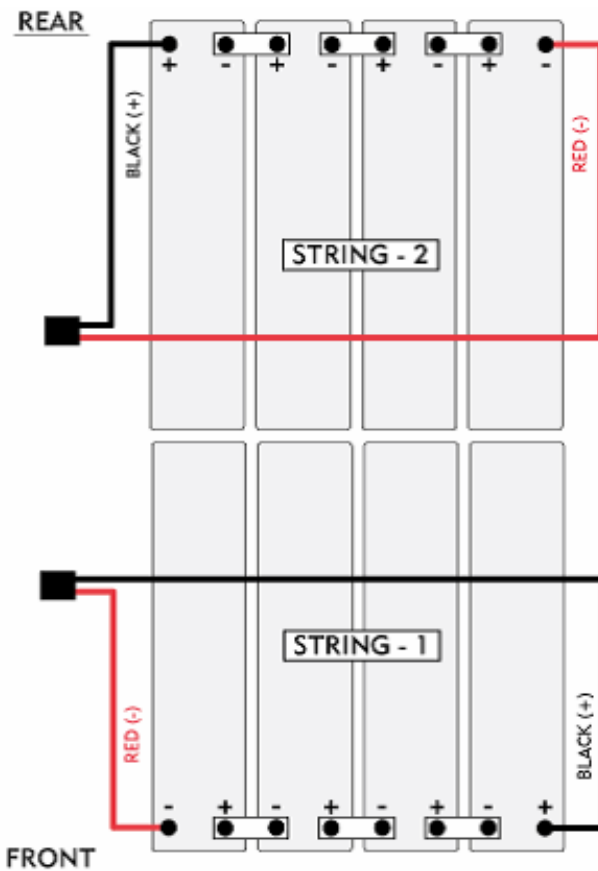

ALERT! Check all connections carefully to verify correct wiring polarities.

- Step 8:** Install the temperature compensation cable lug onto the negative (-) terminal post of String 1.
- Step 9:** Reconnect the three pairs of battery power cables (Anderson connectors) to the power supply leads.
- Step 10:** Replace the front and rear battery compartment doors. See *Operating Cabinet Doors* for instructions.

FieldSmart® Fiber Active Cabinet (FAC) 5400

Installation Manual



Turning Up and Testing the DC Power System

Turn up and test the cabinet DC bulk power system as described below.

To turn up and test the DC power system

Step 1: At the AC load center, verify the following:

- The Main Service Disconnect breaker is **ON**.
- The Main breaker is **ON**.

Step 2: At the AC load center, switch the 30A Rectifier A and Rectifier B breakers **ON**.

Step 3: Verify that the Valere shelf boots up and the rectifier modules are operational.

- If the modules operational and no alarms are present, the shelf controller display reads **SYSTEM OK**.
- If any alarms are present, refer to the *Valere Compact DC Power System Installation and Maintenance* manual for troubleshooting assistance.

Step 4: On the Valere shelf controller face plate, press the UP button once to display plant voltage and current (defaults).

Note: *The Valere shelf controller is programmed at the factory with default settings that enable safe power up and operation. However, you can modify the settings for plant voltage, battery profile, temperature compensation, etc. from the defaults. For basic instructions, see *Programming the Valere Shelf Controller*. For detailed programming instructions, refer to the *Valere Compact DC Power System Installation and Maintenance manual*.*

Step 5: At the DC distribution panel, verify that 5A GMT fuses are installed in positions HX Front and HX Rear. If necessary, install the fuses and verify that the heat exchanger fans start running (if internal temperature is high enough).

Step 6: At the DC distribution panel, switch the 40A battery breakers **ON** to charge the batteries.



FieldSmart[®] Fiber Active Cabinet (FAC) 5400

Installation Manual

Testing Batteries

If the batteries are not fully charged, perform this procedure after charging the batteries.



WARNING! Electrical hazard. Only a qualified technician should perform these procedures.

To test the batteries

- Step 1:** At the DC distribution panel, verify that the battery breakers are **ON**.
- Step 2:** Using a digital volt meter, test the battery connection between the negative and positive battery leads:
- Place the red volt meter lead on the red negative (-) battery lead.
 - Place the black volt meter lead on the black positive (+) battery lead.
 - Verify that the volt meter reads between -46 and -54 VDC.
 - If the reading is outside of these limits, check for connection integrity, replace bad battery cell as applicable, and retest the voltage.
- Step 3:** At the AC load center, set the Main breaker to **OFF**. The fans should continue to run.
- Step 4:** At the AC load center, set the Main breaker to **ON** and verify that power restores to the Valere shelf.

Chapter 8: Installing Equipment and Adding Capacity

This chapter describes how to install optional equipment and components into the cabinet, including expansion equipment to increase system capacity. The cabinet's modular design allows for incremental growth of line capacity and supports field installation of factory options.

Topics Covered

This chapter covers the following topics:

- Installing a protection mounting frame
- Installing a protection block
- Installing a battery heater
- Installing an AC power meter
- Installing a generator connector

Note: Before installing any powered equipment on the rear equipment rack, you must first remove the air plenum cover to enable proper air circulation and cooling to the rear rack. See *Removing the Air Plenum Cover* for instructions.



FieldSmart® Fiber Active Cabinet (FAC) 5400

Installation Manual

Installing a Protection Mounting Frame

The modular design of the cabinet's copper line protection system allows you to incrementally expand line capacity. Protection blocks are housed in a mounting frame that installs on a 23-inch rack. Each mounting frame holds up to six 50-pair protection blocks.

You can field-install protection mounting frames to expand system capacity. The protection system typically resides in the splice compartment for standard configurations, or in the rear compartment for cross-connect configurations.

To install a protection mounting frame

- Step 1:** Unpack the protection mounting frame from the shipping packaging.
- Step 2:** Verify that two ground wires are connected to the mounting frame. Install the ground wires if necessary.
- Step 3:** Mount the protection mounting frame onto the rack as follows:
 - a. Turn the two knobs on the frame counter-clockwise to the open position.
 - b. Attach the mounting frame to the rack using four supplied self-tapping screws.

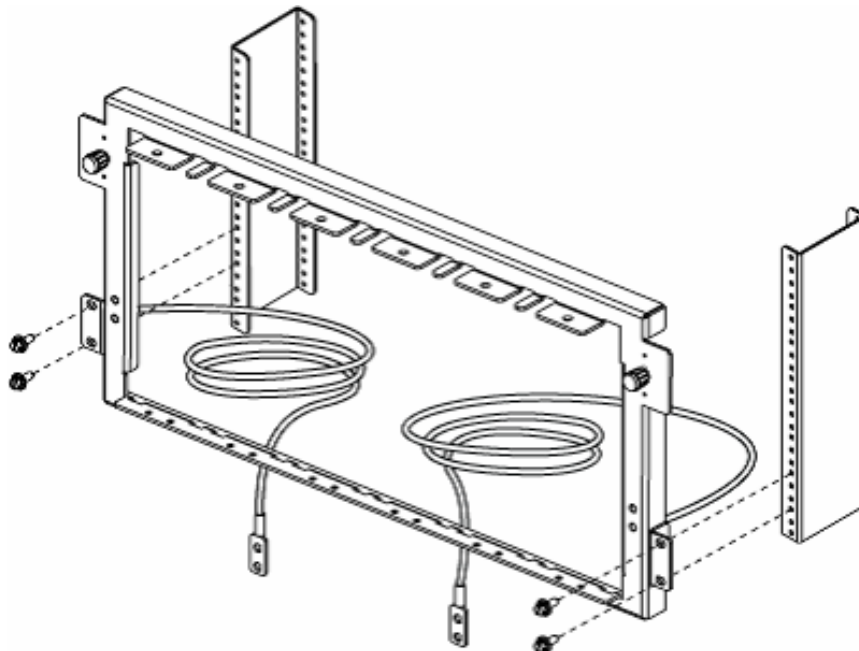

- c. While holding the top of the mounting frame against the rack, turn the two knobs clockwise to secure the frame to the rack in the closed position.

- Step 4:** Route the two frame ground wires to the main ground bar (located at the bottom of the splice compartment). Attach the ground wire lugs to any open position on the main ground bar.

FieldSmart® Fiber Active Cabinet (FAC) 5400

Installation Manual



Installing a Protection Block

The modular design of the cabinet's copper line protection system allows you to incrementally expand line capacity in the field.

You can add protection blocks to expand system capacity. The protection system typically resides in the splice compartment for standard configurations, or in the rear compartment for cross-connect configurations.

To install a protection block

- Step 1:** Unpack the protection block from the shipping packaging.

- Step 2:** On the back of the protection block, remove any cable ties that coil up the two pairs of interface cables (two with MS2 or 710 connectors, two with RJ-21 connectors), if present.

- Step 3:** Locate an open position on the protection mounting frame, then feed the protection block's interface cables through the mounting frame into the area behind it. The protection blocks are typically populated from left to right.

- Step 4:** If the protection system resides in the rear compartment, route the OSP interface cables (MS2 or 710 connectors) into the splice compartment.

- Step 5:** Attach the protection block to the mounting frame as follows:
 - a. Insert the tabs on the bottom of the protection block into the slots on the mounting frame position.

 - b. Pull down the spring-loaded plunger latch at the top of the protection block. While holding the plunger down, rotate the block into the mounting frame. Release the plunger latch to secure it in the frame.



FieldSmart® Fiber Active Cabinet (FAC) 5400

Installation Manual

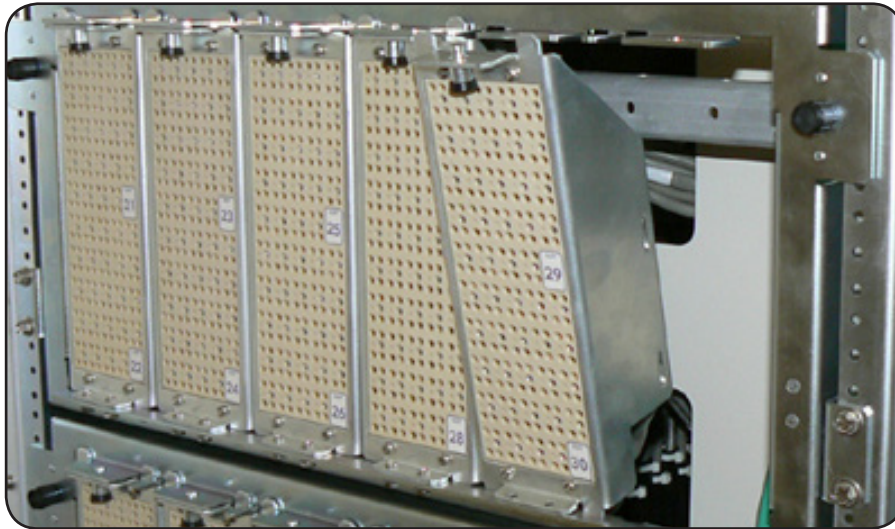

c. Fasten the protection block to the mounting frame using two supplied screws.

Note: The screws provide a critical ground path through the mounting frame to the cabinet's main ground bar.

- Step 6:** On the mounting frame, turn the two knobs counter-clockwise (to the open position), then pull the frame forward to access the area behind the protection blocks.
- Step 7:** Route the two RJ-21 interface cables into the equipment chamber (through the holes in the back wall of the compartment).
- Step 8:** Secure the protection block interface cables to the rack or towel bars with cable ties as needed.

FieldSmart® Fiber Active Cabinet (FAC) 5400

Installation Manual



Installing a Battery Heater

For colder climates, Clearfield recommends using an optional battery heater to prevent batteries from freezing and to prolong battery life. One battery heater supports the maximum of three battery strings. The battery heater is controlled by a thermostat set for the following operation:

- **0° C** – Battery heater turns On.
- **12° C** – Battery heater turns Off.

Note: *The battery heater sits directly underneath the battery string(s). You must install the heater into the battery compartment before installing batteries.*

To install a battery heater

- Step 1:** Unpack the battery heater from the shipping packaging.
- Step 2:** Remove the front battery compartment door. See *Operating Cabinet Doors* for instructions.
- Step 3:** Facing the front battery compartment, orient the battery heater with the heating element on the bottom (face down) and the power cord on the right side, then slide the heater into the battery compartment.
- Step 4:** Route the power cord to the AC outlet (located on the right inside wall of the battery compartment) and plug the cord into the outlet.
- Step 5:** After the batteries are installed, place the thermostat wire for the heater on top of the battery string. See *Installing Batteries* for installation instructions.
- Step 6:** At the AC load center, switch **ON** the 20A Conv. Outlet breaker to apply power.



FieldSmart® Fiber Active Cabinet (FAC) 5400

Installation Manual

Installing an AC Meter

You can mount a commercial AC power meter directly to the exterior of the cabinet if required. The suggested meter mounting location is on the front of the cabinet above the generator connector housing. To install a meter in this location, you must cut a hole in the cabinet wall. For cabinets not equipped with a generator connector, you can remove the plate covering the connector housing and install the AC meter in that location.

After installing an AC power meter, be sure to thoroughly seal the opening. For AC wiring information, refer to the AC wiring diagram on the inside door of the splice compartment.



DANGER! High voltage may be present. Only a qualified electrician should install an AC meter. Follow NEC and local codes when handling power systems.

The figure below shows the suggested mounting location for a single position, 4-terminal, ring-type outdoor AC power meter:

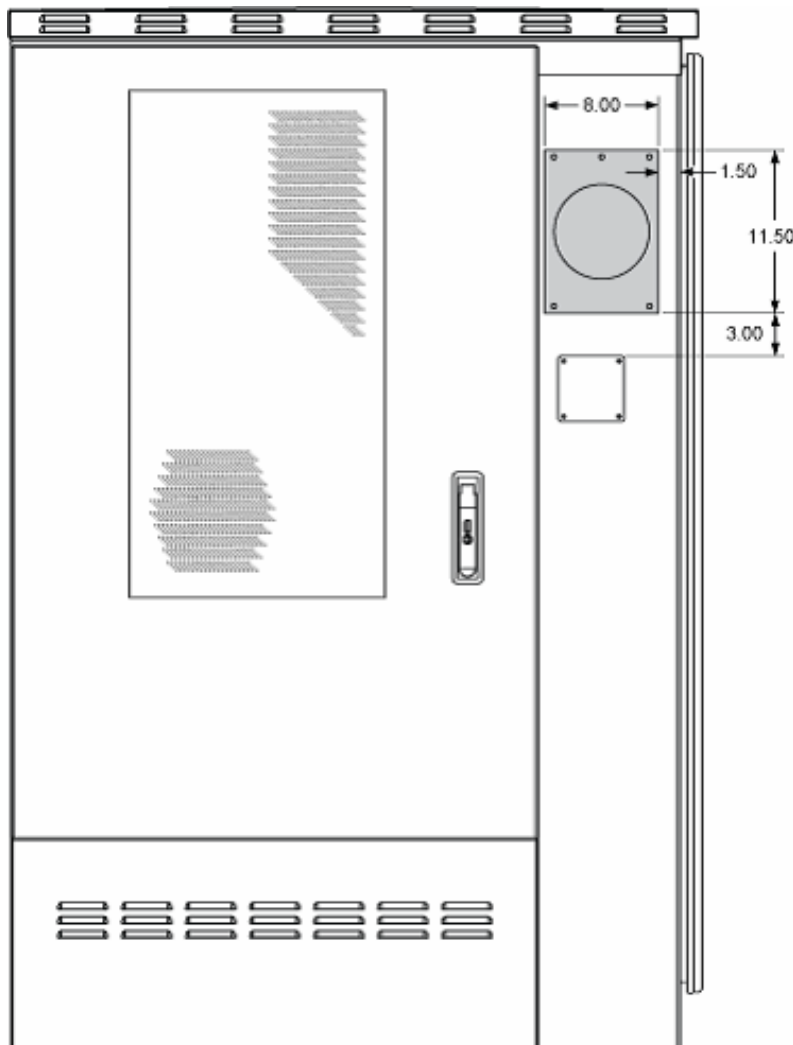

FieldSmart® Fiber Active Cabinet (FAC) 5400

Installation Manual



Installing a Generator Connector

A generator connector allows an external power generator to be connected to the cabinet to sustain services during an AC power outage. The cabinet supports 30 Amp generator connectors. You can install a generator connector in the field as described below. If the cabinet is equipped with charged batteries, this procedure does not affect service.



DANGER! High voltage may be present. Only a qualified electrician should perform this task. Follow NEC and local codes when handling power systems. Do not restore AC power until the task is complete.

To prepare for generator connector installation

Step 1: At the local power transfer switch, disconnect AC power to the cabinet.

Note: *If the cabinet is equipped with charged batteries, this action does not affect service. The equipment automatically switches to battery reserve power.*

Step 2: Open the splice compartment door.

Step 3: At the AC load center, switch the Main Service Disconnect and Main main circuit breakers to **OFF**.

Step 4: Remove the cover panel from the AC load center.

Step 5: Remove the AC duct cover (two panels) as follows:

- a. Loosen (but do not remove) the mounting screws securing the duct cover panels to the fixture.
- b. Slide the upper panel sideways to align its two keyholes with the two mounting screws. When aligned, pull the panel away from the fixture.
- c. Slide the lower panel sideways to align its two keyholes with the two mounting screws. When aligned, pull the panel away from the fixture.

Step 6: Remove the blank plate that covers the mounting fixture as follows:

- a. From inside the splice compartment, remove the nuts from the four studs anchoring the blank plate to the cabinet wall.

Note: *Do not discard the four mounting nuts. The nuts will be reused to install the generator connector.*

- b. At the exterior front of the cabinet, pull the blank plate away from the cabinet wall to expose the connector mounting fixture.



FieldSmart® Fiber Active Cabinet (FAC) 5400

Installation Manual

To install a generator connector

Step 1: Unpack the generator connector from the shipping packaging.

Step 2: For 30 Amp generator connectors, install an adapter plate onto the wall mounting fixture as follows:

- a. Get the adapter plate from the installation kit.
- b. At the exterior front of the cabinet, insert the adapter plate into the mounting fixture, aligning the four studs with the counterpart holes in the wall fixture.
- c. From inside the splice compartment, install four nuts (removed previously) onto the four studs. Tighten the nuts to secure the adapter plate in place.

Step 3: Attach the generator connector to the mounting fixture as follows:

- a. From the exterior front of the cabinet, feed the generator connector wires through the mounting fixture opening into the splice compartment.
- b. Insert the generator connector into the mounting fixture, aligning the four studs with the counterpart holes in the adapter plate (30 Amp model).
- c. From inside the splice compartment, install four nuts onto the four studs. Tighten the nuts to secure the generator connector assembly in place.



FieldSmart® Fiber Active Cabinet (FAC) 5400

Installation Manual



Step 4: Connect the generator connector wires to the AC load center as follows:

- a. Route the generator connector wires up through the AC duct channel and behind the AC load center.
- b. Feed the wires into the AC load center from behind, through the center entry hole on the rear panel.

Note: *If any slack wires hang below the bottom edge of the load center, use cable ties to secure the wires to the back of the rack beneath the load center.*

c. Terminate the generator connector wires to the load center as follows:

- Connect the green wire to the ground bar.
- Connect the white wire to the neutral bar.
- Connect the black and red wires to the Gen. Conn. breaker.

Step 5: Replace the AC duct cover (two panels) and the AC load center cover panel.

Step 6: At the AC load center, switch all breakers to **ON**.

Step 7: At the local power transfer switch, restore AC power to the cabinet.



FieldSmart® Fiber Active Cabinet (FAC) 5400

Installation Manual

Chapter 9: Cabinet Maintenance

This chapter describes how to perform cabinet maintenance, including routine maintenance and corrective maintenance to replace worn or failed parts and equipment.

Topics Covered

This chapter covers the following topics:

- Routine cabinet maintenance
- Replacing parts and equipment

FieldSmart® Fiber Active Cabinet (FAC) 5400

Installation Manual



Routine Maintenance

This section describes how to perform routine maintenance on the cabinet.

Battery Maintenance

Perform routine inspection and maintenance of batteries to improve battery life. Follow the manufacturer's maintenance recommendations. Additional general maintenance guidelines are provided below.

Battery maintenance does not impact cabinet service, provided that an AC power failure does not occur during the maintenance process. Clearfield recommends connecting an external generator to the cabinet while performing battery maintenance to ensure service continuity in the event of an AC outage.



WARNING! Electrical hazard. Batteries contain a stored charge. Only a qualified technician should perform this procedure.



CAUTION! Electrical, chemical, fire, and heat hazard. Handle batteries with care to avoid personal injury or damage to the equipment.



ALERT! To ensure service continuity in the event of an AC outage, connect an external generator to the cabinet while performing battery maintenance.

To perform battery maintenance

- Step 1:** At the DC distribution panel, switch the breaker(s) for the battery string(s) to replace to **OFF**.
- Step 2:** Remove the front and rear battery compartment doors. See *Operating Cabinet Doors* for instructions.
- Step 3:** Remove the batteries from the battery compartment:
- Remove the front seismic protection brackets from around the batteries, if present.
 - Disconnect the battery power cables (Anderson connectors) from the power supply leads.
 - Remove the red and black battery power cables from the terminals at each end of the string.
 - Remove the jumper straps from between the terminals of batteries in the string.
 - Slide the batteries out of the battery compartment.



FieldSmart® Fiber Active Cabinet (FAC) 5400

Installation Manual

Step 4: Visually inspect each battery for defects such as:

- Fractured housing or other physical damage
- Leakage
- Bulging

Note: Replace any battery that displays a defect. See *Replacing Batteries* for instructions.

Step 5: Perform the following maintenance tasks:

- a. Load test each battery to verify that ample current is available to maintain the system.
- b. Ensure that each battery provides 13.5 VDC (plus or minus .2 VDC).
- c. Clean each battery to remove dust, dirt, or corrosion from the battery surface.

Note: Only use water for cleaning the battery surface. Do not use any chemicals.

- d. Clean the battery terminals and apply No-Ox anti-corrosion grease to each.
- e. Record the inspection and maintenance details in the cabinet records per local practice.

Step 6: Inspect the battery compartment for any signs of damage. Clean the compartment and fix any damage to painted areas by removing all rust and dirt from the affected area, and then applying touch-up paint to the area to prevent future corrosion.

Step 7: Re-install the batteries into the battery compartment. See *Installing Batteries* for instructions.

Checking Electrical Components

Check all electrical components in the cabinet for wear at least once a year.

- Check the circuit breakers on the AC load center. Verify that all breakers are in the **ON** position.
- Check the AC surge arrester on the AC load center. Verify that the operational indicators are lit.
- Check the optional Valere power shelf controller module. Verify that the controller display reads **System OK**.
- Check the rectifier modules in the Valere power shelf. Verify that the AC OK and DC OK indicators are lit on each module.
- Check the circuit breakers and fuses on the DC distribution panel. Verify that all applicable breakers are in the **ON** position and that no fuses are blown.
- Check the door-mounted heat exchangers. Verify that the air intake locations are unobstructed and that the fans are running.
- Check the GFCI convenience outlets located in the front and battery compartments. Test the outlets per local code.

If any of the inspected items requires replacement due to failure or damage, replace the item as described in *Replacing Parts and Equipment*.

FieldSmart® Fiber Active Cabinet (FAC) 5400

Installation Manual



Checking Cabinet Surfaces

Clean and inspect the cabinet for contaminants, damage, and wear once a year. Items to check include the following:

Inspect interior surfaces

Items to check inside the cabinet include the following:

- Inspect the interior of the cabinet for signs of visible damage to the metal or paint.
- Note any damage to the metal work. If the damaged metal work interferes with the operation of the equipment shelves or electronics contact Clearfield support for assistance with a resolution.
- Repair damage to the paint using touch-up paint available from Clearfield after cleaning the surface and removing rust.
- Inspect all gaskets around the doors and the roof to ensure a tight secure fit.

Inspect exterior surfaces

Items to check outside the cabinet include the following:

- Inspect the exterior of the cabinet for signs of damage to the metal work or paint.
- Repair damage to the paint using approved type touch-up paint after cleaning the surface and removing rust.
- Note damage to the metal work. If the damaged metal work interferes with any operation of the equipment shelves or electronics contact Clearfield support for assistance with a resolution.
- Clean all surfaces so that they are free of dirt, dust, and foreign material.
- Remove all material from air intake screens and louvers (i.e. spider webs, leaves, etc.).
- Clean the air vents on the heat exchangers and the battery compartment with a dry, soft brush to ensure optimal airflow.

Checking Cable Connections

Check external cable connections at least once a year. External cables are any cable that enters the cabinet from the outside plant.

- Visually inspect all cables for signs of physical damage. If damage is present, cables should be repaired or replaced per local practice.
- Check all outside plant copper connections for complete and secure connection.
- Ensure that all cable management accessories provide a clean appearance. Replace any fastening devices (i.e. cable ties) so that they include all cables being secured.
- Check all fiber optic connectors to ensure that they are securely fastened.
- Check all connections on the cabinet ground bar for a tight and secure fit.
- Check all protector modules and fiber modules to ensure that all devices are securely seated.
- Check all conduits to ensure that any material used to seal between the cable and the conduit is still present and providing a complete seal.



FieldSmart® Fiber Active Cabinet (FAC) 5400

Installation Manual

Replacing Parts and Equipment

This section describes how to replace worn or failed parts and equipment in the cabinet.

Replacing a Cabinet Door

Replacing a cabinet door may become necessary if:

- Cooling capacity must be increased to support the addition of a shelf or third-party equipment (where a factory-installed "blank" door is replaced by an integrated heat exchanger door).
- A door becomes damaged.
- A heat exchanger fails or becomes damaged.

You can replace cabinet doors in the field without impacting service. Order replacement doors from Clearfield.



CAUTION! Cabinet doors are heavy. Handle with care to avoid personal injury or damage to the door. Two people are required to perform this task.

To remove a cabinet door

- Step 1:** If the door is equipped with an integrated heat exchanger, disconnect the power and alarm cables from the heat exchanger.
- Step 2:** Disconnect the ground strap from the door by removing the hex nut. Save the nut to attach the ground strap to the new door.
- Step 3:** Remove the nut, bolt, and washer fastening the wind-stay arm to the bracket inside the door frame.



FieldSmart® Fiber Active Cabinet (FAC) 5400

Installation Manual



Step 4: On the door hinges, disengage the hinge pin lever from its cradle:

a. Top and middle hinges: Lift the pin lever up and rotate it away from the cradle.

b. Bottom hinge: Press the pin lever down and rotate it away from the cradle.

Step 5: Release the hinge pins from the hinge pin channels as follows:

a. Top and middle hinges: Press down on the pin lever until the pin slides free from the channels.

b. Bottom hinge: Lift up on the pin lever until the pin slides free from the channels.

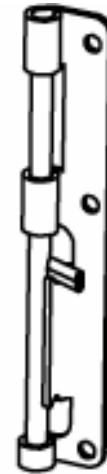

Pin lever engaged

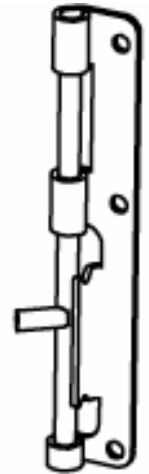

Pin lever disengaged

Step 6: Remove the door from the cabinet.

To install a new cabinet door, follow the instructions in *Installing a Heat Exchanger Door*. The door installation instructions apply to doors with or without an integrated heat exchanger.

Replacing AC Breakers

If a circuit breaker in the AC load center fails or becomes damaged, you can replace the breaker in the field as described below. If the cabinet is equipped with charged batteries, this procedure does not affect service.



DANGER! High voltage may be present. Only a qualified electrician should perform this task. Follow NEC and local codes when handling power systems. Do not restore AC power until the task is complete.

To replace an AC circuit breaker

Step 1: At the local power transfer switch, disconnect AC power to the cabinet.

Note: If the cabinet is equipped with charged batteries, this action does not affect service. The equipment automatically switches to battery reserve power.

Step 2: At the AC load center, switch the Main Service Disconnect and Main main circuit breakers to OFF.

Step 3: Remove the cover panel from the AC load center.

Step 4: Remove any wires from the defective circuit breaker.



FieldSmart® Fiber Active Cabinet (FAC) 5400

Installation Manual

- Step 5:** Remove the defective breaker from the load center and replace it with a new breaker of the same type and rating.
- Step 6:** Reconnect all wiring to the new circuit breaker.
- Step 7:** Replace the AC load center cover panel.
- Step 8:** At the AC load center, switch all breakers to ON.
- Step 9:** At the local power transfer switch, restore AC power to the cabinet.

Replacing DC Breakers and Fuses

If a DC circuit breaker or fuse fails or becomes damaged, you can replace the breaker or fuse in the field as described below.

Replacing Breakers

Circuit breakers protect the power circuits for the equipment shelves and battery strings. The breakers are located on the DC distribution panel.



DANGER! High voltage may be present. Only a qualified electrician should perform this task. Follow NEC and local codes when handling power systems.



WARNING! Risk of electric shock. The following procedure can be performed with the breaker assembly hot, provided that the new breaker is installed in the OFF position.

Note: To avoid an interruption of service, you can replace breakers while the distribution system is hot. The bullet-style breakers used with optional Valere rectifier can be removed with no wiring disconnections. Refer to the Valere DC Distribution Panel manual for more information. If you elect to replace a breaker with the power off, wait until a maintenance window to minimize service impact. To disconnect power to the breakers, switch the 30A Rectifier A and Rectifier B breakers **OFF** at the AC load center and switch the 40A battery breakers **OFF** at the DC distribution panel, then perform the procedure.

FieldSmart® Fiber Active Cabinet (FAC) 5400

Installation Manual



To replace a DC circuit breaker

Step 1: At the DC distribution panel, verify that the breaker to replace is **OFF**.

Step 2: Remove the cover from the DC distribution panel.



WARNING! Risk of electric shock. Set the new breaker to the **OFF** position before installing it.

Step 3: Remove the identified circuit breaker from the housing. The breaker pulls straight out with no connected wiring.

Step 4: Install the new breaker into the vacated housing position.

Step 5: Replace the cover on the DC distribution panel.

Step 6: Switch the new breaker to **ON**.

Replacing Fuses

Fuses protect the power circuits for the heat exchangers and other optional equipment. The fuses are located on the DC distribution panel.

Circuit Type	Fuse Rating	Fuse Type
Heat exchangers	5 Amp	GMT
Optional equipment	5 to 15 Amp	GMT

To replace a fuse

Step 1: At the DC distribution panel, identify the defective fuse.

Step 2: Remove the defective fuse from the fuse position in the DC distribution panel.

Step 3: Replace the fuse with a fuse of the same rating and type.

Step 4: If the fuse fails again do not replace it. Troubleshoot to find the cause of the failure.



Replacing Rectifier Modules (for optional Valere Rectifier)

If a Valere rectifier module experiences a failure in the field, or if you are converting from 30A to 20A rectifier modules (or vice versa), you can replace the module(s) in the field. Rectifier modules are hot-swappable and can be replaced without disconnecting power to the Valere shelf.

Note: *If the Valere shelf is not equipped with a redundant rectifier module, and the load is heavy, Clearfield recommends temporarily installing an additional module into the shelf to carry the load while you replace the failed module.*

To replace a Valere rectifier module

Step 1: Remove an installed rectifier module as follows:

- a. Press the tab on the lower left of the face plate to release the ejector lever.
- b. Pull forward on the ejector lever to unseat the module.
- c. Grasp the module and slide it out of its slot. Set the module aside.

Step 2: Install a new rectifier module as follows:

- a. Insert the new rectifier module into the vacated slot.
- b. Push firmly on the module to seat it in the slot.
- c. Push the ejector lever closed to secure the module in place.

Step 3: Repeat Steps 1 and 2 to replace additional rectifier modules.

As each rectifier module is installed, the shelf controller automatically identifies the new module and configures the system. After all rectifier modules have been installed, the controller displays **System OK**.

If a shelf controller fails, the system remains at the last known settings until a new controller is installed.

FieldSmart® Fiber Active Cabinet (FAC) 5400

Installation Manual



To replace a Valere controller module

Step 1: Remove the installed controller module as follows:

- a. Grasp the top and bottom edges of the display face plate, then gently pull the face plate down and forward to disconnect it from the controller module. Allow the face plate to dangle.
- b. Loosen the set screw and slide the controller module halfway out of the slot.
- c. Disconnect the face plate's display cable from the controller module and set the face plate aside.
- d. Disconnect the temperature probe, alarm, and expansion cables from the controller module.
- e. Pull the controller module completely out of the shelf.

Step 2: Install a new controller module as follows:

- a. Insert the new controller module halfway into the slot.
- b. Reconnect the alarm, temperature probe, and expansion cables to the controller module.
- c. Reconnect the face plate's display cable to the controller. Allow the face plate to dangle.
- d. Push firmly on the module to seat it in the slot, then tighten the set screw.
- e. Re-attach the face plate to the controller module.

When the controller displays **System OK**, it has completed its initialization and is ready to operate on default settings at the Basic Menu level.

Note: For detailed instructions on controller functionality, including how to program the controller module, see the Valere Compact DC Power System Installation and Maintenance manual.



FieldSmart® Fiber Active Cabinet (FAC) 5400

Installation Manual

Replacing Batteries

If a battery or string of batteries fails, becomes damaged, or wears out its life, you can replace the battery or string as described below. Replacing batteries does not impact cabinet service, provided that an AC power failure does not occur during the replacement process. Clearfield recommends connecting an external generator to the cabinet while performing battery maintenance to ensure service continuity in the event of an AC outage.



WARNING! Electrical hazard. Batteries contain a stored charge. Only a qualified technician should perform this procedure.



CAUTION! Electrical, chemical, fire, and heat hazard. Handle batteries with care to avoid personal injury or damage to the equipment.



ALERT! To ensure service continuity in the event of an AC outage, connect an external generator to the cabinet while performing battery maintenance.

To replace batteries

- Step 1:** At the DC distribution panel, switch the breaker(s) for the battery string(s) to replace to **OFF**.
- Step 2:** Remove the front and rear battery compartment doors. See *Operating Cabinet Doors* for instructions.
- Step 3:** In the battery compartment, remove the front seismic protection brackets from around the batteries, if present.
- Step 4:** Identify the #10 AWG battery power cables for the string(s) to replace. Disconnect the identified cables (Anderson connectors) from the power supply leads.
- Step 5:** Remove the red and black battery power cables from the terminals at each end of the string.
- Step 6:** Remove the jumper straps from between the terminals of batteries in the string.
- Step 7:** Remove the batteries from the battery compartment.
- Step 8:** Install the new batteries. See *Installing Batteries* for instructions.
- Step 9:** When finished, replace the front seismic protection brackets, if present.
- Step 10:** Replace the battery compartment doors and switch the battery breaker(s) to **ON**.

FieldSmart® Fiber Active Cabinet (FAC) 5400

Installation Manual



Replacing a Battery Heater

If the battery heater fails or becomes damaged, you can replace the heater in the field as described below. Replacing a battery heater requires the batteries to be removed from the battery compartment.

To replace a battery heater

- Step 1:** Remove the front and rear battery compartment doors. See *Operating Cabinet Doors* for instructions.
- Step 2:** Remove the batteries from the battery compartment, if present. See *Replacing Batteries* for battery removal instructions.
- Step 3:** Unplug the heater power cord from the AC outlet located on the compartment wall.
- Step 4:** Lift and remove the battery heater panel from the battery compartment floor.
- Step 5:** Install the new battery heater into the battery compartment and connect its power cord to the AC outlet. See *Installing a Battery Heater* for instructions.
- Step 6:** Reload and reconnect batteries. See *Installing Batteries* for instructions.



FieldSmart® Fiber Active Cabinet (FAC) 5400

Installation Manual

Appendix A: Reference Information

This appendix provides general reference information about the FAC 5400 cabinet.

Topics Covered

This appendix covers the following topics:

- Cabinet specifications
- Supported batteries
- Rack space available for additional equipment
- Optional Valere rectifier alarm matrix
- Optional Valere rectifier settings (battery profiles)
- Programming instructions for the optional Valere shelf controller module
- Rectifier module usage guidelines
- Cabinet wiring diagrams

FieldSmart® Fiber Active Cabinet (FAC) 5400

Installation Manual



Specifications

Specifications for the Clearfield FAC 5400 cabinet follow:

Dimensions	
Exterior	73.5" H x 48.5" W x 48.5" D
Equipment compartment (interior)	56.0" H x 35.0" W x 45.0" D
Splice compartment (interior)	71.0" H x 43.5" W x 11.0" D
Battery compartment	14.0" H x 35.0" W x 45.0" D
Weight	
960 lines (standard)	1271 lbs (shipping weight)
960 lines (with cross-connect)	1435 lbs (shipping weight)
Enclosure Mounting	
Concrete pad (cast-in-place or pre-cast)	Clearfield cast-in-place template option
Vertical surface (wall or H-frame)	Clearfield wall/H-frame mounting kit option
Equipment Mounting	
Total equipment mounting space	94 inches (47" front; 47" rear)
Rack attributes	23-inch EIA standard; swing frame design Center mount, 12" equipment depth
Environmental	
Heat exchangers	(2) door mounted, 1850 Watt each Fans turn on at 30C (1500 RPM), 40C (3000 RPM) High temp alarm at 75C, low temp alarm at 0C
Cooling capacity	3700 Watts
Thermal operating range	-40C to +46C
Environmental alarming	(8) environmental and intrusion alarms
Electrical	
AC power system	220-240 VAC load center (110-120 VAC option) Dual feeds to DC power shelf (2) duplex convenience outlets (GFCI protected)
Generator connector (option)	30 Amp NEMA twist-lock (Hubbell)
DC power system	Optional Valere compact power shelf; up to (4) rectifier modules (30A or 20A) Optional Valere DC distribution shelf (12 position) Redundant feeds to equipment
Battery backup	Support for (2) strings of front post VRLA batteries (-48 VDC per string) Battery heater
Cable Entrance	
AC service entry	(1) 3-inch diameter entry port
Outside plant entry	(1) 20.5 x 6 inch entry box (1) 10.5 x 6 inch entry box
Compliance	
Safety	UL 60950 CAN/CSA-C22.2 No. 60950
EMC	FCC Part 15, Class A ICES-003, Class A
Telcordia	GR-487-CORE, Issue 2 GR-63-CORE, Issue 1 (NEBS)



FieldSmart® Fiber Active Cabinet (FAC) 5400

Installation Manual

Supported Batteries

The FAC 5400 supports the following batteries. For a list of battery distributors, contact your sales representative.

Manufacturer	Model	Capacity (Ah) per String	Max # of Strings
Northstar	NSB 170FT	170 Ah	2
Fiamm	12FAT 155	155 Ah	2
GNB Marathon	M12V155FT	155 Ah	2
C+D Dynasty	TEL-150F	150 Ah	2
Northstar	NSB 100FT	100 Ah	2
PowerSafe	SBS C11	92 Ah	2

Rack Space for Additional Equipment

In addition to its standard factory-installed equipment, the FAC 5400 can also house third-party equipment. The total storage capacity for third-party equipment varies by configuration, as shown.

Configuration	Front	Rear
480 lines (standard)	26" (15 RU); 12" deep	47" (27 RU); 12" deep
480 lines (cross-connect)	26" (15 RU); 12" deep	26" (15 RU); 12" deep
960 lines (standard)	9" (5 RU); 12" deep	47" (27 RU); 12" deep
960 lines (cross-connect)	9" (5 RU); 12" deep	5" (3 RU); 12" deep

FieldSmart® Fiber Active Cabinet (FAC) 5400

Installation Manual



Valere Rectifier Alarm Matrix

The Valere power shelf detects and reports multiple alarm conditions in the cabinet, but only two umbrella alarms are reported through to the equipment shelf: Rectifier Major (RECT/MJ) and Rectifier Minor (RECT/MN). The following table lists the Valere alarms that may be reported by the equipment shelf as Rectifier Major or Rectifier Minor.

Alarm Condition	Display Severity	
	Major	Minor
AC Fail	X	
High Voltage Warning	X	
High Voltage Shut Down	X	
Battery on Discharge	X	
Any LVD Warning		X
Any LVD Open	X	
Distribution Open	X	
Redundant Capacity		X
Current Share		X
Single Rectifier Failure	X	
Multiple Rectifier Failure	X	
System Communication		X
High Temperature		X
Thermal Runaway (if T Comp is enabled)		X
Battery Test Failure		X



FieldSmart® Fiber Active Cabinet (FAC) 5400

Installation Manual

Valere Rectifier Setpoints

The following table lists the setpoints used by Valere power shelf controllers in FAC cabinets. Use the applicable profile based on battery type: Valve-Regulated Lead Acid (VRLA), Nickel Cadmium (NiCad), or Lithium Metal Polymer (LMP).

Parameter	Description	Battery Type			
		BC500 BC2000	A VRLA	B NiCad	C LMP
Float Voltage	The voltage to which the rectifiers will regulate the plant during float mode		54.0	54.4	55.0
HVSD Setpoint	The controller will shut down the rectifiers if the plant voltage exceeds this setpoint		58.0	58.0	57.6
HVA Setpoint	The controller will issue a High Voltage Alarm if the plant voltage exceeds this setpoint		57.0	57.0	56.6
BOD Alarm	The controller will issue a Battery-On-Discharge alarm if the plant voltage falls below this setpoint		48.0	48.0	53.0
LVD Warning (All)	The controller will issue a Low Voltage Disconnect Warning if the plant voltage falls below this setpoint		44.0	44.0	44.0
LVD 1 Open	The system LVD contactor will open if the plant voltage falls below this setpoint		42.0	42.0	42.0
LVD 1 Reconnect	The system LVD contactor will reconnect if the plant voltage exceeds this setpoint		50.0	50.0	50.0
LVD 1 Reconnect Delay Time	The amount of time (seconds) that the plant voltage must exceed the LVD reconnect setpoint prior to reconnecting the LVD contactor		20	20	20
LVD 2 Open	The system LVD contactor will open if the plant voltage falls below this setpoint		42.0	42.0	42.0
LVD 2 Reconnect	The system LVD contactor will reconnect if the plant voltage exceeds this setpoint		50.0	50.0	50.0
LVD 2 Reconnect Delay Time	The amount of time (seconds) that the plant voltage must exceed the LVD reconnect setpoint prior to reconnecting the LVD contactor		20	20	20
Ringer AC Output Voltage	The RMS value of the ringing AC sine wave output		86	86	86
Ringer Output DC Offset Voltage	The DC offset value applied to the output AC sine wave		-Vfloat	-Vfloat	-Vfloat
Ringer Output Frequency	The frequency of the ringer AC output sine wave		20	20	20
T Comp Enable	Enables thermal compensation		Enabled	Disabled	Disabled
Temperature Units	Select either degrees C or F		C	C	C
Hi Temp Thermal Comp Start Temp	The controller begins to reduce the float voltage when the highest measured battery temperature reaches this value		35.0	n/a	n/a
Hi Temp Thermal Slope	If battery temperature is above the start temperature, the controller will linearly reduce the plant voltage by this slope		72.0	n/a	n/a
Hi Temp Thermal Comp Stop Voltage	The minimum voltage to which the controller will reduce plant voltage for thermal compensation		50.5	n/a	n/a
Lo Temp Thermal Comp Start Temp	The controller begins to reduce the float voltage when the highest measured battery temperature reaches this value		10.0	n/a	n/a
Lo Temp Thermal Slope	If battery temperature is below the start temperature, the controller will linearly increase plant voltage by this slope		50.0	n/a	n/a
Lo Temp Thermal Comp Stop Voltage	The maximum voltage to which the controller will raise plant voltage for thermal compensation		54.5	n/a	n/a

FieldSmart® Fiber Active Cabinet (FAC) 5400

Installation Manual



Parameter	Description	BC500 BC2000	Battery Type		
			A VRLA	B NiCad	C LMP
Thermal Sense	Selects temperature sensing device to use for battery temperature compensation; Internal sensor or External temp probes		External	Internal	Internal
Thermal Runaway Clamp Temperature	The temperature at which the controller will reduce the Float Voltage to Runaway Clamp Voltage		55.0	n/a	n/a
Thermal Runaway Clamp Voltage	The Float Voltage to which the controller will reduce for temperatures above Runaway Clamp Voltage		50.0	n/a	n/a
Communication Alarm	A minor alarm is set if any rectifier stops communicating or is removed. User action is required to clear the alarm		Disabled	Disabled	Disabled
Current Share Alarm	A minor alarm is set if the output current of any rectifier exceeds current sharing tolerances		Enabled	Enabled	Enabled
Redundancy Alarm	A minor alarm is set if the number of installed rectifiers will not support N+1 redundancy required by the load		Disabled	Disabled	Disabled
Controller Fail Float Voltage Reduction	Rectifier float voltage will revert to a user defined voltage in the event of a controller failure or removal. If disabled, rectifiers will stay at last voltage setting		Disabled	Disabled	Disabled
Controller Fail Fallback Voltage	The voltage to which the rectifiers will revert in the event of a controller failure		52	52	52
Battery Discharge Test Enable	Enables the battery discharge test function		Disabled	Disabled	Disabled
Battery Discharge Test Duration	The length of time in minutes the battery discharge test is scheduled to run		30	30	30
Battery Discharge Test Alarm Threshold	If the battery terminal voltage falls below this value at any time during the discharge test, a battery alarm is set		52	52	52
Battery Discharge Abort Threshold	If the battery terminal voltage falls below this value at any time during the discharge test, the discharge test is aborted and an alarm is set		LVD 1 Open +1V	LVD 1 Open +1V	LVD 1 Open +1V
T Comp Masking Enabled during Batt Discharge Test	Select whether temperature compensation is disabled or remains enabled during battery discharge testing		Disabled	Disabled	Disabled
Battery Equalize Enable	Enables the battery equalize function		Disabled	Disabled	Disabled
Battery Equalize Voltage	The value of the float voltage during the battery equalize interval		56.5	56.5	56.5
Battery Equalize Duration	The amount of time in hours of the battery equalize interval		12	12	12
High Temperature Alarm Threshold (user access thru web only)	The temperature (deg C) at which any connected thermal sensing device (internal or external) will issue an alarm. Alarm will clear when temperature drops to less than 2 deg C below threshold.		98	98	98
High Temperature Alarm Release	The temperature (deg C) below which the High Temperature Alarm clears.		93	93	93



FieldSmart® Fiber Active Cabinet (FAC) 5400

Installation Manual

Programming the Valere Shelf Controller

The Valere shelf controller is factory programmed with appropriate settings for FAC cabinets. You can change the factory defaults for the battery profile, temperature compensation, float voltage, and other settings. This section provides basic instructions for accessing and programming the Valere shelf controller. For additional information on programming the Valere shelf controller, see the *Valere Compact DC Power System Installation and Maintenance* manual.

System configuration access

You can check the system status or modify settings from the controller display panel and three button keypad. Use the UP and DOWN buttons to scroll through the functions. Use the MENU button to select and/or enter a sub-menu.

The controller provides three menu levels: Basic, Advanced, and Administrator. When the display reads **System OK**, the controller is at the Basic menu level. Use the UP/DOWN buttons to sequentially view basic parameters. Press and hold the MENU button for 5 seconds to access the Advanced menu level. Scroll to and select **Log In** to access the Administrator level. The default username is **Admin** (case sensitive) and the default password is **5001**. *The Administrator level allows you to modify all the plant settings.* To enter the password, use the MENU button to select the number (the character to be selected flashes) in the password, and use the UP/DOWN buttons to toggle to the next character. Toggle to the right-most arrow key and press MENU to enter. The instructions below provide more detail.

To access the Administrator menu

- Step 1:** With controller display showing **System OK**, press and hold **MENU** button for 5 seconds.
- Step 2:** Scroll to **CHOOSE: >LOGIN** and press **MENU**. The display shows **PASSWORD ->0000<-** with the first 0 flashing.
- Step 3:** Press **MENU** to change first digit value. Each press of the **MENU** button advances the value by one. Pressing **UP** selects that value for the first digit, which stops flashing, and advances to the second digit, which begins flashing.
- Step 4:** Repeat procedure above for all four digits. Press **UP** to select **<**, which will then flash, and press **MENU**.
- Step 5:** Controller displays **OK: ADMIN** for 5 seconds.

FieldSmart® Fiber Active Cabinet (FAC) 5400

Installation Manual



Changing the battery profile

You can verify or change the battery profile from the PRESET menu. Select the appropriate profile (VRLA or LMP) for the type of battery used in the cabinet. For a list of the default profile settings, see *Valere Rectifier Setpoints*.

To select a battery profile

- Step 1:** From the ADMIN menu, choose **>PRESET**.
- Step 2:** Press the MENU button once. The controller should display LMP.
- Step 3:** Press the UP button until the appropriate battery profile (LMP, NiCAD, or VRLA) displays.
- Step 4:** Once the appropriate battery profile is selected, press MENU for 5 seconds until the menu jumps back to **CHOOSE:>CONFIG**.
- Step 5:** Press the UP button once to display **CHOOSE:>EXIT**.
- Step 6:** Press the MENU button to return to the basic menu.

Changing rectifier settings

You can verify or change the rectifier settings from the SETPOINT submenu.

To modify rectifier settings

- Step 1:** From the Administrator menu, choose **>SETPOINT**.
- Step 2:** Press the UP button to toggle through the features on the SETPOINT submenu. Each feature can be enabled or disabled by pressing **MENU**. On each feature with adjustable voltage or amperage, you can adjust the value by pressing MENU, then adjusting the value with the UP/DOWN buttons.
- Step 3:** Modify the settings per your application requirements.
- Step 4:** Press the UP button until **>EXIT SETPOINT** displays. Press the MENU button to exit.



FieldSmart® Fiber Active Cabinet (FAC) 5400

Installation Manual

Rectifier Module Usage Guidelines

The Valere power shelf supports up to four rectifier modules in 20 Amp or 30 Amp options.

Use the table below to determine how many rectifier modules to use for your application based on the total load.

Expected Max Power Output per Rectifier Module			Load per Rectifier Shelf (Power Supplied)	# Rectifier Modules Required ¹	
				20A	30A
20A	22A * 54V =	1188W	1W to 1188W	1	1
			1188W to 1782W	2	1
30A	33A * 54V =	1782W	1782W to 2364W	2	2
			2364W to 3564W	3	2

¹ Clearfield recommends using an N+1 rectifier module scheme for redundancy. The value shown represents N only, without a redundant module.

Note: When using 20A rectifier modules, loads greater than 3564W per power shelf require 4 modules, prohibiting N+1 module redundancy. If a load is greater than 3564W per power shelf, use 30A modules instead to allow for N+1 redundancy.

Wiring Diagrams

For wiring diagrams of the FAC 5400 cabinet power, ground, and alarm systems, refer to Clearfield's website, www.seeclearfield.com

FieldSmart® Fiber Active Cabinet (FAC) 5400

Installation Manual



Standard Warranty

Clearfield warrants to the original purchaser of the Product sold hereunder is free from defects in material and workmanship under normal use and service, subject to exceptions stated herein. Product purchased is warranted as follows: Clearfield designed and branded Products are warranted for three (3) years; Products manufactured by Clearfield to customer prints and/or specifications are warranted for one (1) year; and any Product Clearfield acquires from or through a third-party manufacturer or distributor and resells to Customer as the original customer will carry the manufacturer's pass-through warranty, if any. In all cases, the warranty period commences on the date of shipment to the original purchaser.

Warranty Claim Procedure

If any Product purchased from Clearfield is found defective under the above warranty, the following basic procedure must be followed:

1. Customer must contact Clearfield and obtain a Return Materials Authorization
2. Following authorization, the Customer ships the product-freight collect-to Clearfield's manufacturing facility
3. Clearfield shall repair or replace the defective Product at its sole option and discretion, and return the repaired or replacement Product to Customer's site, freight prepaid

Note: If the Product is not found to be defective by Clearfield, the product will be returned to the Customer and the customer billed for freight in both directions.

View our warranty policy here: <https://www.seeclearfield.com/warranty.html>

Limitations of Warranty

Correction of defects by repair or replacement, at the option of Clearfield Inc, shall constitute the exclusive sole remedy for a breach of this limited warranty. Clearfield shall not be liable under any circumstances for any special, consequential, incidental, punitive, or exemplary damages arising out of or in any way connected with the product or with agreement to sell product to buyer, including, but not limited to damages for lost profits, loss of use, or for any damages or sums paid by buyer to third parties. The foregoing limitation of liability shall apply whether the claim is based upon principles of contract, warranty, negligence or other tort, breach of statutory duty, principles of indemnity or contribution, the failure of any limited or exclusive remedy to achieve its essential purpose, or otherwise.

Clearfield will not be responsible for any labor or materials costs associated with installation or incorporation of Clearfield products at customer sites, including any costs of alteration, replacement or defective product, or any field repairs.

Other Limitations

Clearfield assumes no warranty liability regarding defects caused by:

1. Customer's modification of Product, excepting installation activities described in Clearfield documentation
2. Customer re-packaging of Product for shipment to third parties or destinations other than those originally shipped to by Clearfield, or any defects suffered during shipping where the Product has been re-packaged
3. Customer's installation or maintenance, excepting activities described in and performed in accordance with Clearfield documentation
4. Customer's improper or negligent use or application of Product
5. Other causes external to the Product, including but not limited to accidents, catastrophe, acts of God, government action, war, riot, strikes, civil commotion, sovereign conduct, or the acts or conduct of any person or persons not party to or associated with Clearfield
6. Environmental factors and weathering resulting in aging and damage not necessary or applicable to the function of the product



FieldSmart® Fiber Active Cabinet (FAC) 5400

Installation Manual

Proprietary Notice

Information contained in this document is copyrighted by Clearfield, Inc. and may not be duplicated in full or part by any person without prior written approval of Clearfield, Inc.

Its purpose is to provide the user with adequately detailed documentation to efficiently install the equipment supplied. Every effort has been made to keep the information contained in this document current and accurate as of the date of publication or revision.

However, no guarantee is given or implied that the document is error free or that it is accurate with regard to any specification.

Technical Support

Clearfield, Inc. can be contacted for any issues that arise with the supplied product.

If you need to return the supplied product, you must contact the Clearfield, Inc. Customer Service Department to request a Returned Materials Authorization (RMA) number.

Clearfield, Inc.
7050 Winnetka Ave N
Minneapolis, MN 55428

Toll Free: 800.422.2537
Phone: 763.476.6866
Fax: 763.475.8457

Customer Support: sales@clfd.net
Technical Support: techsupport@clfd.net