

FieldSmart® Fiber Active Cabinet (FAC) 900

Installation Manual



CLEARFIELD



FieldSmart® Fiber Active Cabinet (FAC) 900

Installation Manual



Table of Contents

About This Guide.....	6
Chapter 1: Fiber Active Cabinet 900 Product Overview.....	7
Cabinet Description.....	8
Cabinet Features.....	9
Cabinet Options.....	10
FAC 900 Battery Riser Description.....	11
FAC 900 Expansion Module Description.....	12
Cabinet and Expansion Module Views.....	13
Cabinet and Expansion Module Dimensions and Weights.....	17
Chapter 2: Installation Considerations.....	21
Installation Process Overview.....	22
Installation Guidelines.....	23
Space Requirements.....	25
General Safety Recommendations.....	28
Installation Kits.....	29
User-Supplied Items.....	30
Cabling Requirements.....	31
Chapter 3: Preparing the Installation Site.....	32
Installing a Ground Circuit.....	33
Constructing a Concrete Pad.....	36
Pad Construction Guidelines.....	36
Assembling the Cast-In-Place Template.....	42
Preparing the Site.....	43
Casting the Pad.....	44
Installing a Pre-Cast Concrete Pad.....	45
Preparing the Site.....	45
Installing a Pre-Cast Pad.....	46
Installing a Wall/H-Frame Mount Kit.....	47
Wall/H-Frame Mounting Configurations and Drawings.....	47
Wall/H-Frame Mounting Guidelines.....	51
Preparing the Site.....	52
Installing the Wall/H-Frame Mounting Fixture.....	53
Installing the Stabilizer Bracket(s).....	56



FieldSmart® Fiber Active Cabinet (FAC) 900

Installation Manual

Installing a Foundation Vault.....	57
Preparing the Site.....	57
Installing the Foundation Vault.....	58
Chapter 4: Installing the Cabinet and Expansion Module.....	59
Unpacking the Cabinet, Expansion Module or Risers.....	60
Operating a Cabinet or Expansion Module Door.....	61
Preparing the Cabinet for Installation.....	63
Preparing the EXM for Installation.....	64
Installing the Cabinet or Riser on a Concrete Pad.....	65
Installing an EXM (and Riser) on a Concrete Pad.....	67
Installing the Enclosure(s) on a Wall or H-Frame.....	72
Removing the Lifting Details.....	75
Chapter 5: Installing Local AC Power.....	76
Installing the Cabinet and EXM Ground Connections.....	77
Installing AC Power (208-240 VAC).....	79
AC Load Center: Installing Power.....	79
AC Junction Box: Installing Power.....	80
Chapter 6: Installing and Splicing Outside Plant Cables.....	82
Bonding Cable Sheaths.....	83
Installing Fiber Cable.....	84
Installing Outside Plant Fiber Cable.....	84
Splicing Fibers.....	86
Routing and Terminating Fibers.....	87
Connecting Fibers to the Equipment.....	88
Installing Metallic Cables.....	89
Removing the Battery Enclosure.....	89
Installing Outside Plant Metallic Cables.....	90
Splicing Metallic Cables.....	92
Reinstall the Battery Enclosure.....	93
Installing 5-Pin Protection Modules.....	93
Sealing Cable Entry Location.....	94

FieldSmart® Fiber Active Cabinet (FAC) 900

Installation Manual



Chapter 7: Turning Up the Cabinet Power System	95
Turning Up the Power System (Local Power)	96
Checking the Ground Connection	96
Checking the AC Power Supply Voltage	97
Installing the Rectifier Modules	98
Installing VRLA Batteries	99
Turning Up and Testing the DC Power System	102
Chapter 8: Installing Equipment and Adding Capacity	108
Installing a Protection Mounting Frame	109
Installing a Protection Block	110
TE LSA-Plus Cross-Connect System	112
Installing an AC Meter	116
Installing a Battery Enclosure	117
Installing a Battery Heater	118
Installing a Generator Connector	122
Installing a Heat Exchanger Door	124
Installing Fiber Management Options	125
Installing a GPON Splitter Cage and Fiber Distribution Bulkhead Frame	127
Connecting PON Splitter Fibers to the OLT Equipment	129
Installing a Fiber Termination Assembly	134
Installing PON Splitter Assemblies and Fibers	136
Installing an LGX Case Fiber Distribution Panel	142
Chapter 9: Cabinet Maintenance	143
Routine Maintenance	144
Checking Cabinet Surfaces	144
Checking Electrical Components	144
Checking Cable Connections	145
Checking the Heat Exchanger	145
Battery Maintenance	146



FieldSmart® Fiber Active Cabinet (FAC) 900

Installation Manual

Replacing Parts and Equipment	148
Removing a Cabinet Door	148
Installing a Cabinet Door	149
Replacing AC Breakers	150
Replacing Rectifier Modules (Alpha Cordex Rectifier Option)	151
.....	
Replacing Batteries	152
Replacing a Battery Heater	153
Appendix A: Reference Information	154
Specifications	155
Alpha Cordex HP Rectifier Alarms and Controller Settings	156
Supported Batteries	156
Wiring Diagrams	156
Standard Warranty	157
Proprietary Notice	158
Technical Support	158

FieldSmart® Fiber Active Cabinet (FAC) 900

Installation Manual



About This Guide

Purpose

This document provides a general installation practice for the Clearfield FAC 900 outdoor cabinet. This document also provides a general description of the cabinet and its subsystems, and guidance for planning, site preparation, power installation, splicing to the outside plant, component installation and expansion, and cabinet maintenance.

Intended Audiences

This document is intended for use by network planning engineers, outside plant engineers, field support personnel, and craft personnel responsible for cabinet installation, splicing, equipment installation, and maintenance.

Federal Communications Commission (FCC) Statement

This equipment has been tested and found to comply with the limits for a Class A digital device, pursuant to Part 15 of the FCC rules. These limits are designed to provide reasonable protection against harmful interference when the equipment is operated in a commercial environment. This equipment generates, uses, and can radiate radio frequency energy, and, if not installed and used in accordance with the instruction manual, may cause interference to radio communications. Operation of this equipment in a residential area may cause harmful interference; the user will be required to correct the interference at his expense.

Safety Notices

This document uses the following safety notice conventions.



DANGER! Danger indicates the presence of a hazard that will cause severe personal injury or death if not avoided.



WARNING! Warning indicates the presence of a hazard that can cause severe personal injury if not avoided.



CAUTION! Caution indicates the presence of a hazard that can cause minor to moderate personal injury if not avoided.



ALERT! Alert indicates the presence of a hazard that can cause damage to equipment, damage to software, loss of data, or service interruption if not avoided.



DANGER! CLASS 1 LASER PRODUCT. INVISIBLE LASER RADIATION PRESENT. Fiber optic radiation can cause severe eye damage or blindness. Do not look into the open end of an optical fiber.



FieldSmart® Fiber Active Cabinet (FAC) 900

Installation Manual

Chapter 1: Fiber Active Cabinet 900 Product Overview

This chapter provides a general description of the base Clearfield FAC 900 outdoor cabinet and Expansion Module (EXM), including standard features and options.

Topics Covered

This chapter covers the following topics:

- A description of the FAC 900 cabinet
- A list of cabinet features
- A list of cabinet options
- A description of the optional EXM
- Views of the cabinet and EXM compartments
- Views of the cabinet and EXM dimensions

FieldSmart® Fiber Active Cabinet (FAC) 900

Installation Manual



Cabinet Description

The Clearfield FAC 900 cabinet is an environmentally-controlled outdoor enclosure designed to house and protect network electronics equipment, providing copper and fiber based broadband services. The compact, low profile FAC 900 supports both copper and fiber applications from a remote node location deep inside the customer serving area, beyond the direct reach of the carrier Central Office. The modular and flexible design of the FAC 900 supports an easy migration from copper based services to fiber-to-the-premises (FTTP), focusing on the mixed deployment of a copper and fiber infrastructure.



The base FAC 900 cabinet has a single compartment that houses electronics equipment together with high density fiber and copper plant terminations, enabling deployment of a broad suite of applications from a single node. The electronics area is equipped with a vertically-oriented 19-inch equipment rack that provides 8RU of mounting space.

The FAC 900 supports local or remote power configurations. The local power configuration includes an optional internal battery enclosure to support battery reserve power.

The modular design of the cabinet supports incremental system expansion, lowering initial deployment costs while maintaining the capacity for future growth. Modular components designed for expansion include the Expansion Module (EXM), compact service units, fiber management capacity, copper line protection, power modules, and cooling elements.



FieldSmart® Fiber Active Cabinet (FAC) 900

Installation Manual

Cabinet Features

Standard features of the FAC 900 cabinet include:

Enclosure Design

- Environmentally sealed design protects from dust and water intrusion
- GR-487 enclosure compliant, and ANSI-UL-67 / CSA C22.2 panel board safety compliant
- Environmentally rated from -40C to +46C (per GR-487)

Equipment Support

- 19-inch equipment rack provides 9RU of mounting space
- GPON and AE fiber management options supporting up to 384 subscriber fiber drops with an internal battery enclosure installed, or up to 576 subscriber fiber drops for GPON applications without an internal battery enclosure installed (SC connectors); up to 18 integrated PON splitters
- Mechanical support for copper 5-pin protection panel and fiber termination assemblies
- Modular, scalable copper line protection (50-pair block increments, 384 pairs maximum); 768 copper pair protection or sixteen 50-pair pro-panels blocks can be supported in the FAC 900 by deploying the internal battery housing in the EXM
- Front access door with 50W/C° Heat Exchanger

Power (Local)

Standard features for the local power configuration include:

- 208/240 VAC load center (ETL-listed); 30 Amp capacity
- AC main/service disconnect breaker
- AC surge suppressor
- Duplex convenience outlet (GFCI protected)
- Optional Alpha non-LVD Cordex HP 1.2kW 1RU rectifier shelf provides -48 VDC bulk power
- 1 + 1 protected 1200W (25A) rectifier modules
- GMT fuse-protected DC supply to equipment (28 positions)
- Interior battery enclosure in vented compartment
- Up to 190Ah battery reserve capacity

FieldSmart® Fiber Active Cabinet (FAC) 900

Installation Manual



Cabinet Options

Common options for the FAC 900 cabinet include:

Enclosure Mounting

- Concrete pad mounting: site-cast pad (using Clearfield pad template) or pre-cast (third-party supplied)
- Wall or frame mounting (using Clearfield mounting kits)
- Stake platform mounting (using Clearfield mounting kit)
- Foundation vault mounting (third-party supplied)

FAC 900 Modular Expansion

- 23-inch rack based Expansion Module (EXM) for increased fiber management, integrated copper cross-connects, or battery capacity

Copper Protection & Trunking, Splicing & Distribution, Cable Management

- Copper line protection for up to 384 lines; MS2 or 710 interface connectors
- CAT5 interface cabling from the line protection blocks
- 12-, 24-, 48- or 96-position fiber splice or distribution panels (19-inch mount)
- 6- and 12-position dual LGX fiber distribution panel (19- or 23-inch mount)
- GPON and AE fiber management options supporting up to 384 subscriber fiber drops with an internal battery enclosure installed, or up to 576 subscriber fiber drops for GPON applications without an internal battery enclosure installed (SC connectors); up to 18 integrated PON splitters

Power

- Local power support (commercial AC power supply); additional options include:
 - 208/240 VAC input AC load center
 - 120/240 VAC input AC power junction box
 - Generator connector (Hubbell); 30A NEMA twist lock with breaker
 - 1+1 rectifier module redundancy (25A modules)

Battery Support (local power configurations)

- Northstar (OEM) 100Ah VRLA battery string and installation kit
- Saft (OEM) 100Ah Ni-Cd battery string and installation kit
- Secondary battery housing kit (supports second 100Ah battery string installed in an EXM)
- 110/120 VAC Battery heater kit for VRLA batteries



FieldSmart® Fiber Active Cabinet (FAC) 900

Installation Manual

FAC 900 Battery Riser Description

The Clearfield FAC 900 Battery Riser is an environmentally-controlled outdoor enclosure that mounts under the base of the FAC 900 cabinet.

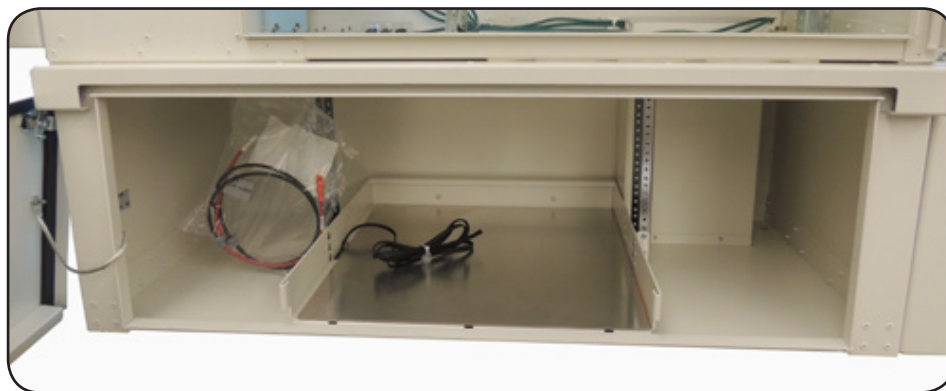

Clearfield provides an optional AC line operated 150W battery heater mat which turns on at 40°F to increase battery capacity in cold environments. Battery mats are available in 120VAC and 240VAC versions.

FieldSmart® Fiber Active Cabinet (FAC) 900

Installation Manual



FAC 900 Expansion Module Description

The Clearfield FAC 900 Expansion Module (EXM) is an environmentally-controlled outdoor enclosure that mounts adjunct to the base FAC 900 cabinet, allowing the expansion of rack space to the usable sealed capacity of the cabinet. You can install the EXM at the time of initial deployment of the cabinet, or later as an expansion.

The EXM can be mounted on the rear or left side of the base FAC 900 cabinet, as shown below.



**Rear Mount
(In-line configuration)**



**Side Mount
(L-configuration)**

The field installable EXM provides the ability to grow the FAC 900 cabinet to support rack space for:

- migration of copper loops to fiber drops.
- additional subscriber fiber distribution endpoints.
- additional copper line protection.
- a secondary or alternative integrated battery enclosure.

The EXM offers an ideal platform for migrating copper access services to fiber access infrastructure and electronics, supporting an equal concentration of copper protection blocks and fiber distribution frames.

Clearfield also offers an FAC 900 EXM Riser that is used when a Battery Riser is also mounted under the FAC 900 cabinet. This is an environmentally-controlled outdoor enclosure that mounts under the base of the FAC 900 FAC 900 EXM.

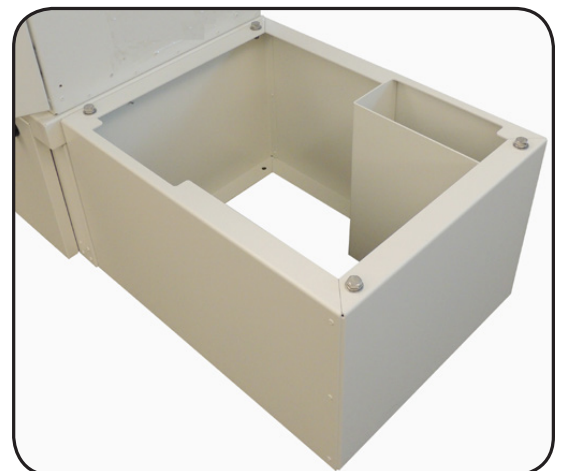



FieldSmart® Fiber Active Cabinet (FAC) 900

Installation Manual

Cabinet and Expansion Module Views

Views of the base FAC 900 cabinet and Expansion Module (EXM) follow.

Base Cabinet Front Compartment

The base cabinet front compartment provides 19 inches of vertical rack space (9RU), and houses the cabinet power system and electronics equipment. The cabinet power system consists of an AC load center or AC junction box and DC rectifier shelf.



**FAC 900 Front
(local power)**

FieldSmart® Fiber Active Cabinet (FAC) 900

Installation Manual



Base Cabinet Side Compartment

The base cabinet side compartment provides access to the cable entry locations, main ground bar, and fiber management or copper line protection. For fiber access, the fiber management accessories may vary greatly according to the ordered options. For copper access, the line protection may include up to eight 50-pair protection blocks. The side compartment also houses an internal battery enclosure for local power configurations. The battery enclosure supports an optional battery heater.



**FAC 900 Side
(local power)**



FieldSmart® Fiber Active Cabinet (FAC) 900

Installation Manual

Expansion Module Compartment

The EXM compartment provides access to cable entry locations and rack space to support additional fiber management or copper line protection. For fiber access, the fiber management accessories may vary greatly according to the ordered options. For copper access, the line protection may include up to eight 50-pair protection blocks. The EXM compartment also houses a secondary or alternative interior battery enclosure for local power configurations. The battery enclosure supports an optional battery heater.



EXM
(local power)

FieldSmart® Fiber Active Cabinet (FAC) 900

Installation Manual



Cabinet Side and Expansion Module Compartments

A view of an in-line configuration follows, with the EXM mounted on the rear of the FAC 900 cabinet.

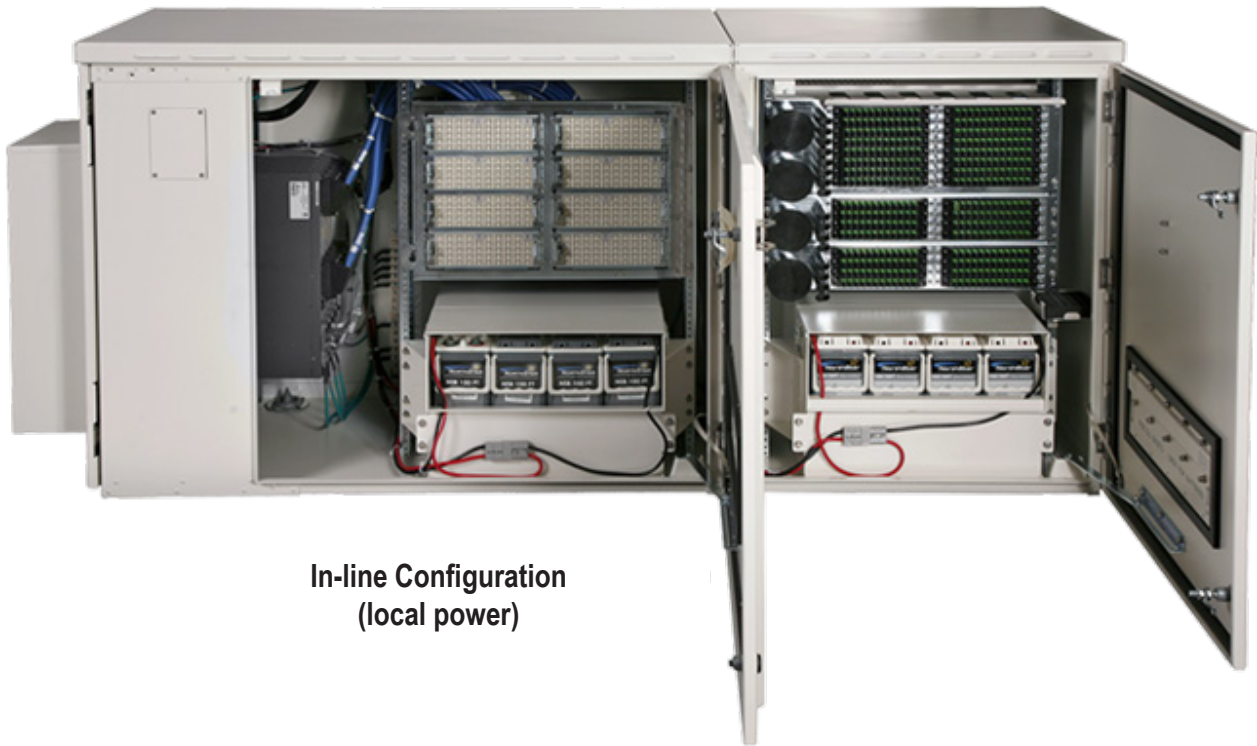

**In-line Configuration
(local power)**



FieldSmart® Fiber Active Cabinet (FAC) 900

Installation Manual

Cabinet and Expansion Module Dimensions and Weights

Dimensions and weights for the base FAC 900 cabinet and Expansion Module (EXM) follow.

Cabinet Dimensions and Weights

The external dimensions of the base FAC 900 cabinet are shown below.

Dimension	Measurement (SAE)	Measurement (Metric)
Height	36 inches	91 cm
Width	24 inches	61 cm
Depth	48 inches	122 cm

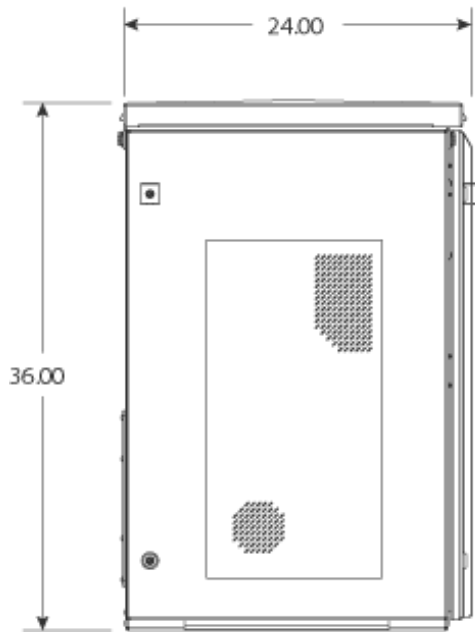

Front

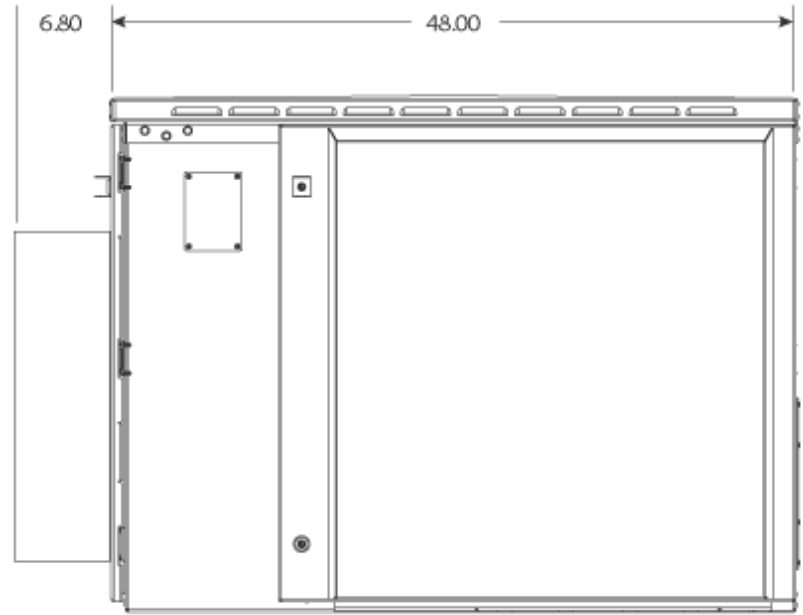

Side

The approximate shipping weight of the base FAC 900 cabinet is shown below.

Configuration Options	Weight (SAE)	Weight (Metric)
Equipped with protection panels and internal battery enclosure	90 lb	132 kg

FieldSmart® Fiber Active Cabinet (FAC) 900

Installation Manual



Expansion Module Dimensions and Weights

The external dimensions of the EXM are shown below.

Dimension	Measurement (SAE)	Measurement (Metric)
Height	36 inches	91 cm
Width	24 inches	61 cm
Depth	28.6 inches	74 cm

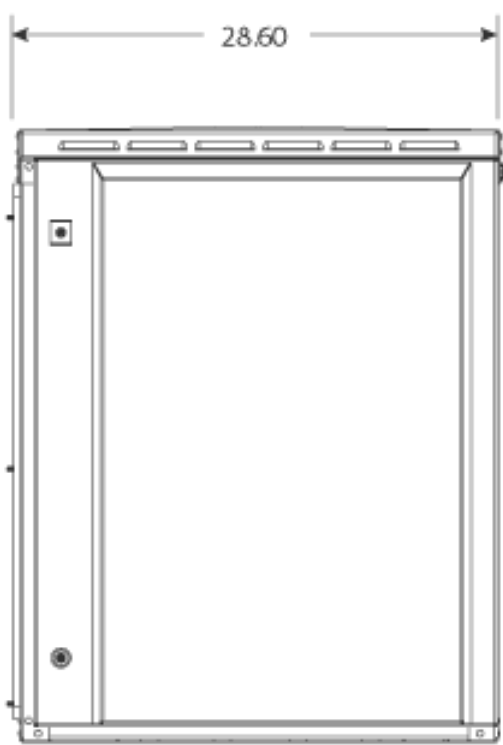

Front

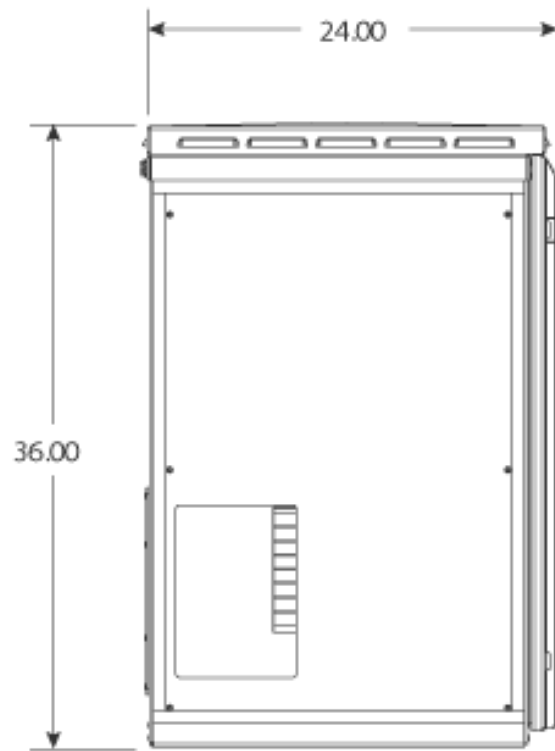

Mating Side

The approximate shipping weight of the (empty) EXM is shown below.

Weight (SAE)	Weight (Metric)
50 lb	23 kg



FieldSmart® Fiber Active Cabinet (FAC) 900

Installation Manual

In-Line Configuration Dimensions

The external dimensions of the in-line configuration are shown below, with the EXM mounted on the rear of the FAC 900 cabinet.

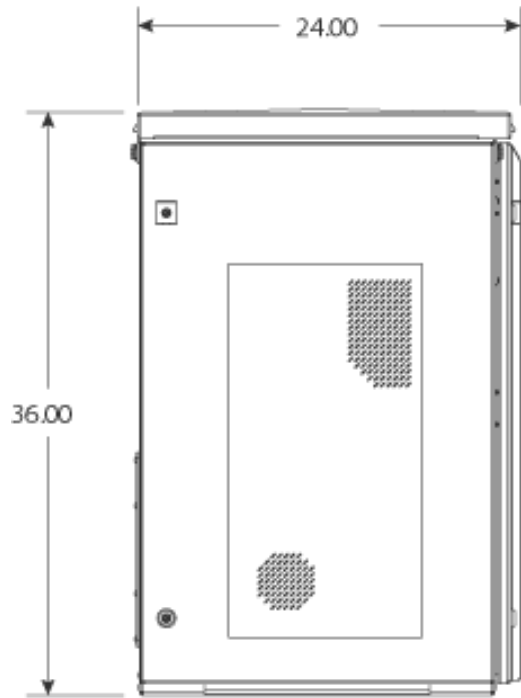

Front

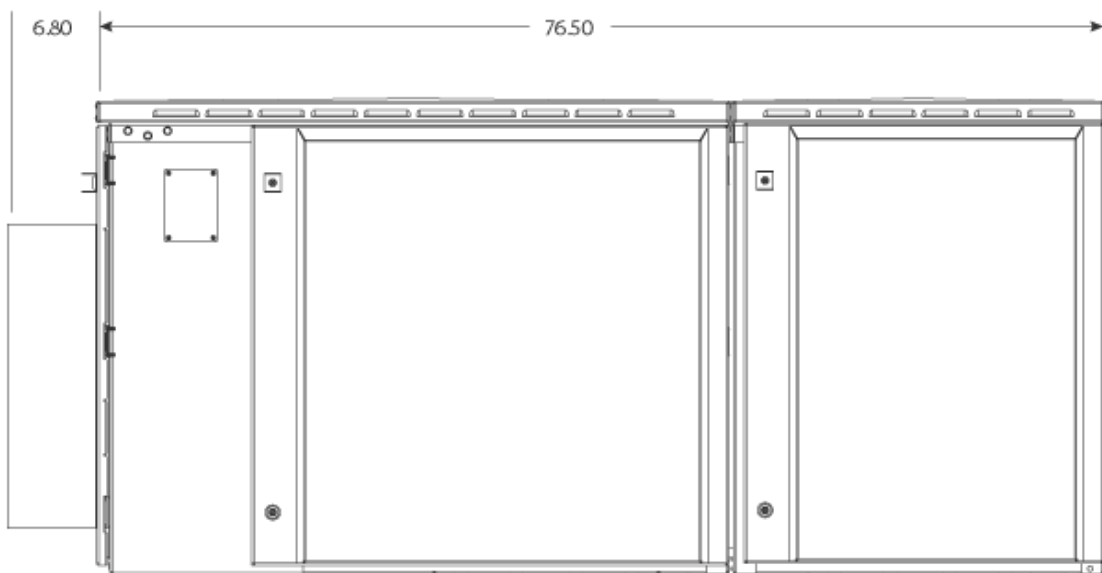

Side

FieldSmart® Fiber Active Cabinet (FAC) 900

Installation Manual



L-configuration Dimensions

The external dimensions of the L-configuration are shown below, with the EXM mounted on the side of the FAC 900 cabinet.

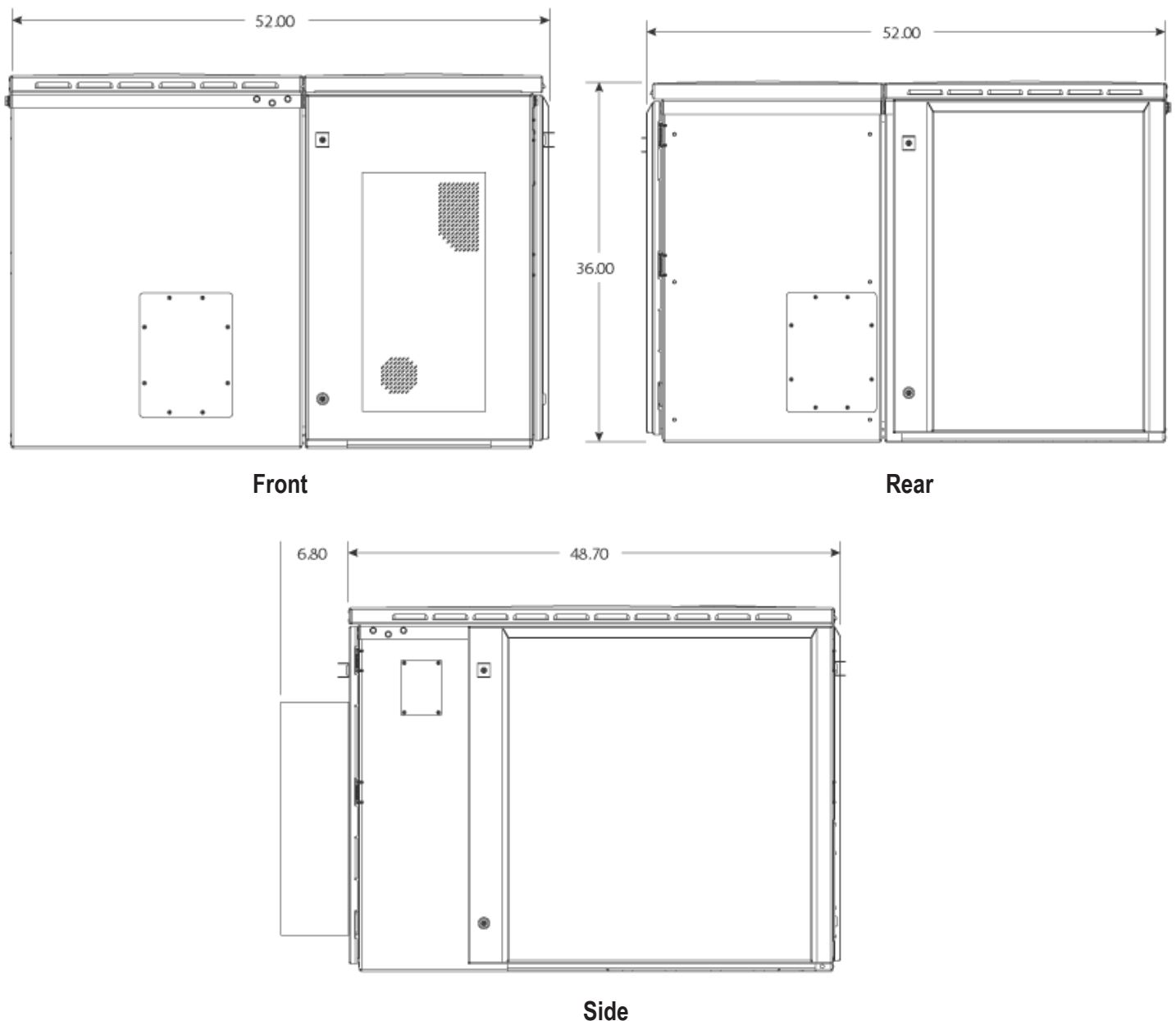

Note: For clearance and space requirements when mounting the EXM on the rear or side of the base FAC 900 cabinet, refer to Space Requirements.



FieldSmart® Fiber Active Cabinet (FAC) 900

Installation Manual

Chapter 2: Installation Considerations

This chapter provides general considerations for cabinet installation. Review this information before starting the cabinet installation process.

Topics Covered

This chapter covers the following topics:

- Installation process overview
- Installation guidelines
- Space requirements
- General safety recommendations
- Installation kit contents
- User-supplied items
- Cabling requirements

FieldSmart® Fiber Active Cabinet (FAC) 900

Installation Manual



Installation Process Overview

The cabinet installation process involves the following high-level steps:

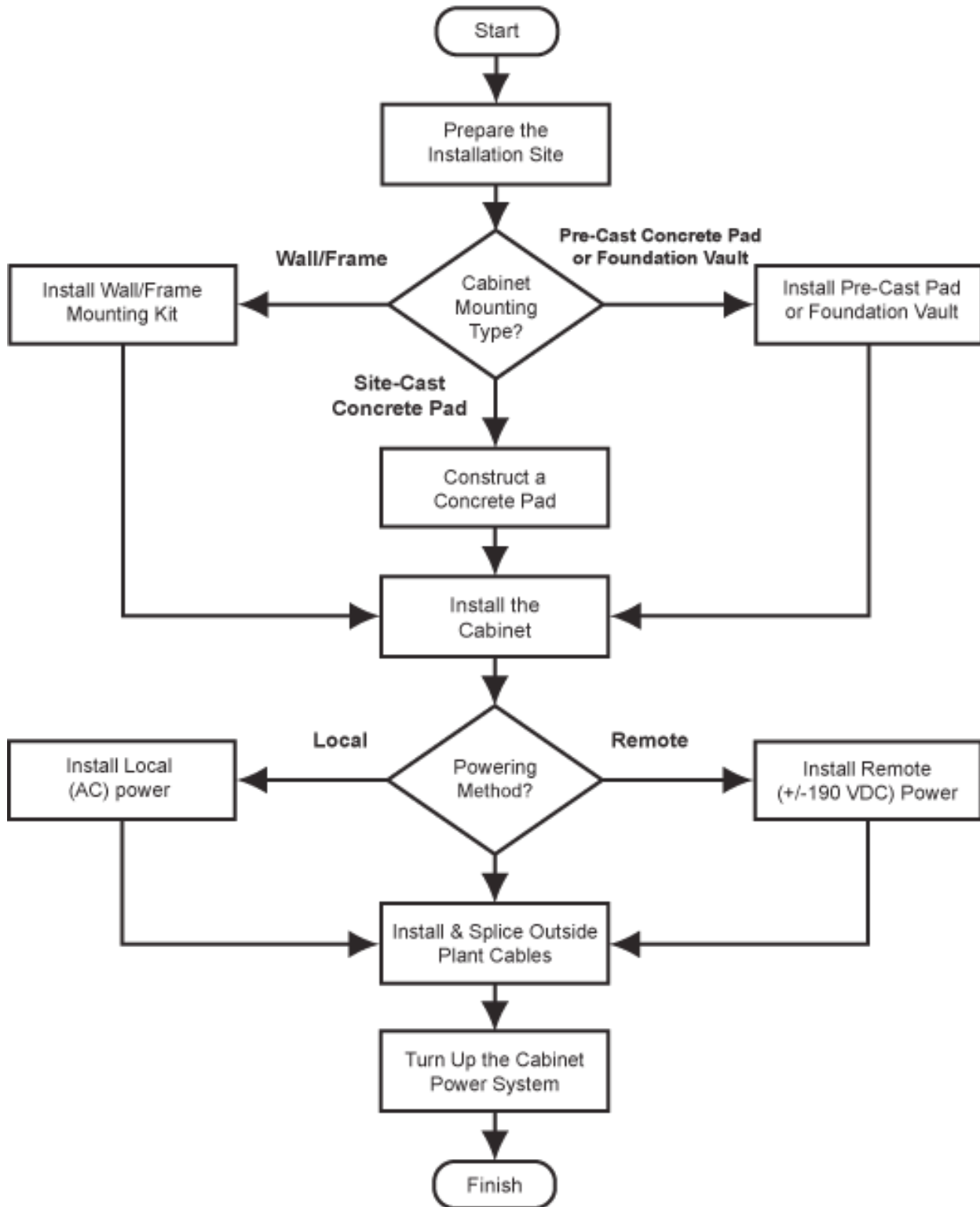



FieldSmart® Fiber Active Cabinet (FAC) 900

Installation Manual

Installation Guidelines

Review the following guidelines before starting installation activities.

General Guidelines

Follow these general guidelines and practices:

- Read this document completely before starting any installation activities.
- Only qualified personnel should perform the procedures described in this document.
- Follow standard safety precautions when performing installation and maintenance tasks.
- Always wear standard safety gear when performing installation and maintenance tasks (hard hats/safety headgear, eye protection, insulated gloves).
- For safety, keep bystanders and other unauthorized personnel away from work operations at all times.
- Do not perform installation activities when the threat of lightning is present.
- **Warning ! - Seal all cable entry locations immediately after the cabinet is installed to prevent ground moisture from condensing inside the cabinet and damaging equipment.**

Site Selection

The location of a cabinet installation site should be carefully planned in advance. Consider the following factors when selecting an installation site:

1. Functional requirements:

- **Suitable terrain.** Whenever possible, the cabinet should be located in an area with a firm flat soil surface that does not require extensive earth work. The location should not be constantly damp or prone to flooding. Check soil maps of potential sites for subsurface conditions.
- **Grounding properties.** The earth at the cabinet location should have a low ground impedance to provide an effective grounding system for lightning protection and safety. Perform ground testing to determine the grounding requirements.
- **Safety.** Whenever possible, the cabinet should be located on vacant property away from motor traffic to reduce injury risks to maintenance personnel or damage to equipment. On streets and highways, avoid locations near busy intersections or curves in the road. Erecting guard rails or concrete pillars can provide additional safety barriers against motor traffic.
- **Solar exposure.** Whenever possible in hot or warm climates, avoid locations with heavy exposure to direct afternoon sun, so as to maximize the life of electronics equipment in the cabinet. High outdoor temperatures and heavy solar exposure raise temperatures inside cabinets, a condition that can reduce the life span of equipment. Conversely, wind exposure improves thermal conditions in a cabinet, so locations that do not block wind are desirable.

FieldSmart® Fiber Active Cabinet (FAC) 900

Installation Manual



2. Accessibility requirements:

- **Easement size.** Select a location with an easement that provides enough space to walk around the perimeter of the cabinet with its doors open.
- **Right-of-Way.** Secure a permanent location on private property, whenever possible. Obtain a firm right-of-way agreement that includes right of access. Avoid locations in public rights-of-way.
- **Electrical access.** Locally-powered cabinets must have access to commercial AC power. Verify the availability of AC service at potential cabinet locations.
- **Parking.** Whenever possible, the cabinet should be located in an area that provides sufficient parking space for installation and maintenance vehicles.



FieldSmart[®] Fiber Active Cabinet (FAC) 900

Installation Manual

Space Requirements

The cabinet configuration determines clearance and space requirements. Clearfield offers the following cabinet configurations for the FAC 900:

- **Stand-alone configuration:** Base FAC 900 cabinet
- **In-line configuration:** FAC 900 with an Expansion Module (EXM) mounted on the rear of the cabinet
- **L-configuration:** FAC 900 with an EXM mounted on the left side of the cabinet

For each configuration, the minimum clearance area around the cabinet site must be free of permanent impediments to allow full swing of the cabinet doors. This area must be kept clear of obstructions at all times to provide adequate access for all installation and maintenance activities.

Stand-alone configuration

The illustration below shows the clearance and space requirements for a stand-alone FAC 900 cabinet.

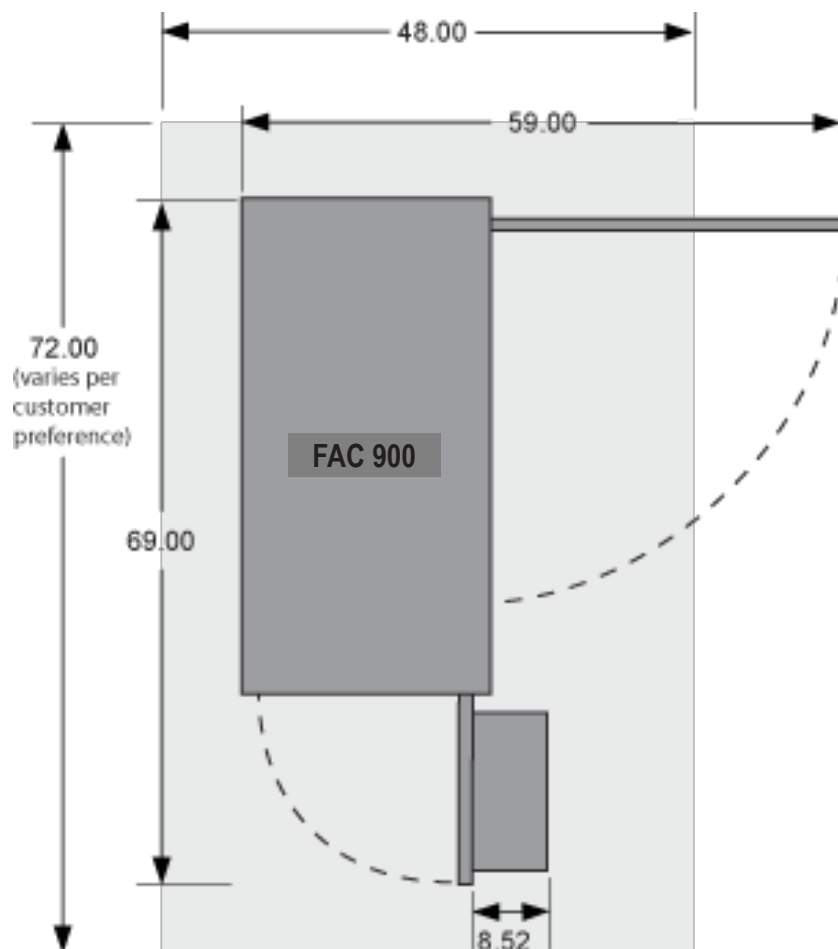

FieldSmart® Fiber Active Cabinet (FAC) 900

Installation Manual



In-line configuration

The illustration below shows the clearance and space requirements for an in-line FAC 900 configuration.

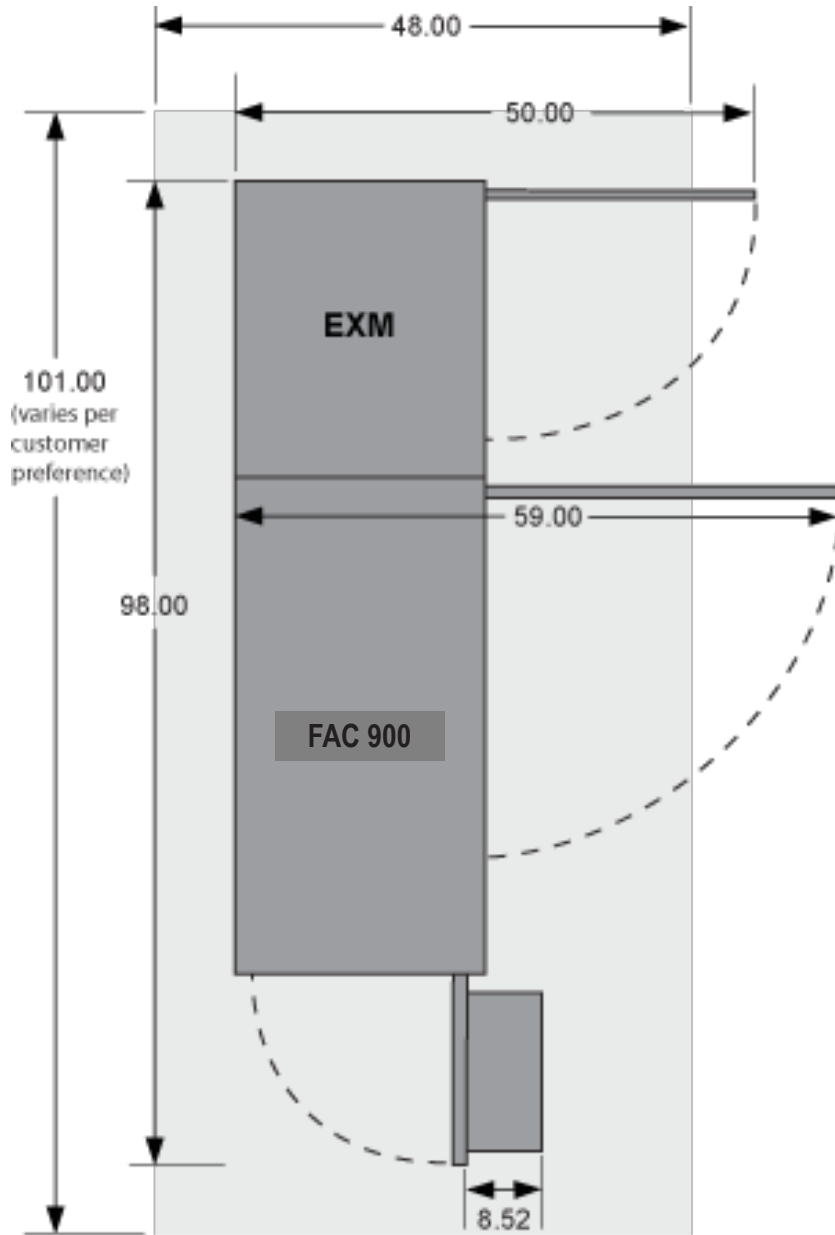



FieldSmart® Fiber Active Cabinet (FAC) 900

Installation Manual

L-configuration

The illustration below shows the clearance and space requirements for an FAC 900 L-configuration.

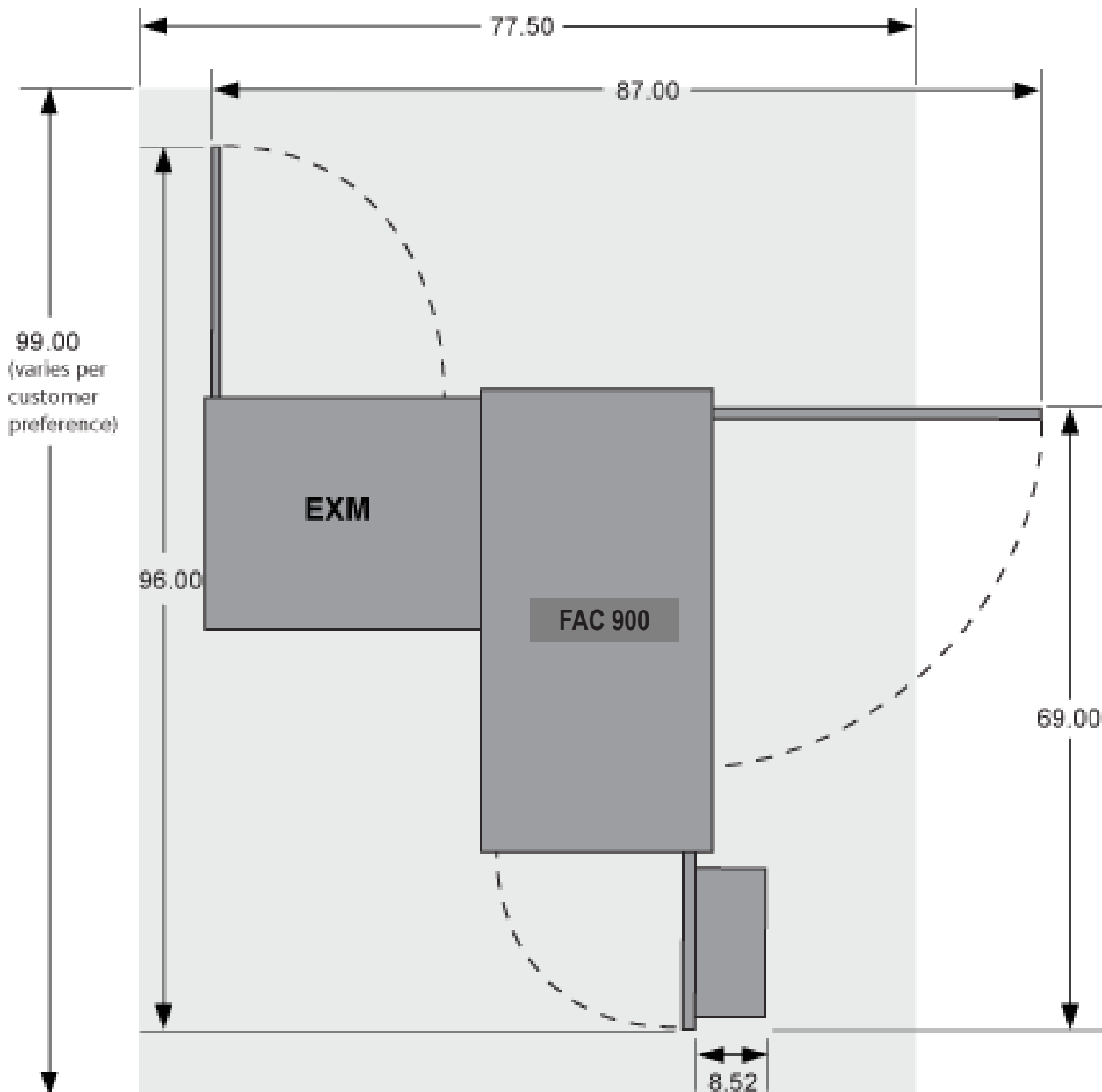

FieldSmart® Fiber Active Cabinet (FAC) 900

Installation Manual



General Safety Recommendations



WARNING! Only trained, qualified technical personnel should perform the procedures described in this document. These procedures involve potentially hazardous activities, including handling of heavy equipment and exposure to high electrical energy, which could cause injury to untrained personnel.



DANGER! Risk of high power current surge and electric shock. Read and understand all power procedures before performing tasks. Take necessary precautions and use appropriate insulated tools when working with power. This equipment must be installed, operated, and serviced by qualified technical personnel only.



WARNING! The cabinet and its components are heavy. Handle with care to avoid personal injury or damage to the equipment.



DANGER! CLASS 1 LASER PRODUCT. INVISIBLE LASER RADIATION MAY BE PRESENT. Fiber optic radiation can cause severe eye damage or blindness. Do not look into the open end of an optical fiber.



CAUTION! Batteries contain a stored charge. Handle batteries with care.



ESD ALERT! Beware of electrostatic discharge. Follow standard ESD precautions. Always wear a grounded ESD wristband to avoid damaging the electronic equipment.



FieldSmart® Fiber Active Cabinet (FAC) 900

Installation Manual

Installation Kits

Clearfield supplies an installation kit with both the cabinet and EXM that includes materials required for installation. The installation kit contents for the cabinet and EXM are listed below. Check to verify that your kit contains the listed items.

<input checked="" type="checkbox"/>	Qty	Item Description
	1	Telco hex key, 5/16" (for cabinet door)
	1	Hex security driver, 5/32" (for access panels)
	1	Isolation mat
	1	Vent cover (for side door; included in installation kit when cabinet/EXM includes an internal battery enclosure)
	4	Hex nuts (for pad mounting)
	4	Flat washers (for pad mounting)
	4	Split lock washers (for pad mounting)
	4	1/2" hex cap screws (for pad mounting)
	1	Ground cable (EXM installation kit only)
	2	Line identification labels (for protection blocks)
	1	Product label (adhere to inside cabinet wall)
	1	Sealant mix for cable entry locations (500g bag)
	12	Tie wraps

FieldSmart® Fiber Active Cabinet (FAC) 900

Installation Manual



User-Supplied Items

Supply the following items for cabinet installation.

Tools

Bring the following tools to the installation site:

- Power drill with universal socket and screwdriver bit sets
- Hammer drill with bit set
- Socket wrench/nut driver set (standard)
- Box wrench set (standard)
- Screwdriver set (standard)
- Beam Level
- Insulated needle-nose pliers
- Wire stripper
- Wire cutters
- Crimp tool
- Compression crimping tool
- Fiber cleaver
- Fiber splicer
- Modular MS2 or 710 splicing tool
- RB Razor-Sharp Cutting Edge knife, or another similar tool
- Wire brush (to clean drill hole for a 1/2-13 inch hole concrete insert)

Materials

Bring the following materials to the installation site:

- Leveling shims
- Silicone sealant
- Two-hole compression ground lug #2-6 AWG, 3/4-inch spacing (for earth ground wire)
- MS2 or 710 connectors for copper line splicing
- Strain relief for #6-8 AWG wiring
- (4) 1/2-13 inch concrete inserts (for EXM installations)
- River stone rock (to fill EXM riser outside plant cable entry location)
- Plastic sheeting

Equipment

Bring the following equipment to the installation site:

- Digital multi-meter
- Optical power meter
- Digital multi-function test set



FieldSmart® Fiber Active Cabinet (FAC) 900

Installation Manual

Cabling Requirements

Cables supplied to the cabinet must meet the following minimum requirements.

Function	Facility	Requirements
Power		
Ground	Copper	6 AWG solid bare copper wire (to earth ground circuit); terminates to ground bar with screw lug
AC (local power)	Copper	8–10 AWG stranded copper; Follow National Electric Code (NEC) and local codes

Note: Local climatic conditions, site conditions, or local practices may require adjustments to cabling requirements.

FieldSmart® Fiber Active Cabinet (FAC) 900

Installation Manual



Chapter 3: Preparing the Installation Site

This chapter describes how to prepare the FAC 900 installation site for cabinet placement, including establishing the cabinet mounting structure. You can construct a concrete foundation pad using the Clearfield pour-in-place template, and install an optional 6-inch or 12-inch riser.

For all mounting configurations, Clearfield requires installation of an earth ground circuit at the installation site to provide lightning protection.

Topics Covered

This chapter covers the following topics:

- Installing a ground circuit at the installation site.
- Constructing a concrete pad.
- Installing a pre-cast concrete pad.
- Installing a wall/H-frame mount kit
- Installing a stake platform kit
- Installing a composite foundation vault



FieldSmart® Fiber Active Cabinet (FAC) 900

Installation Manual

Installing a Ground Circuit

Clearfield requires installing an earth ground circuit (earth electrode) at the installation site to provide protection from electric shock for equipment and personnel. The ground circuit may consist of a simple copper rod driven into the earth or a complex system of buried rods and wires. The lower the resistance of the electrode-to-earth connection, the more effective the ground system for safety and lightning protection.

Proper grounding conditions and requirements vary per site. The National Electric Code (NEC) specifies a maximum ground impedance of 25 ohms. Clearfield recommends achieving a ground impedance of no greater than 5 ohms wherever practical. If 5 ohms or less cannot be achieved, the maximum ground impedance should meet local codes or the NEC requirement of 25 ohms, whichever is less.

Grounding options

The cabinet main ground system must be bonded to a suitable earth ground circuit, which may include any of the following:

- **Ground rod(s):** A ground rod consists of a simple copper rod driven into the earth. A ground rod connects to the main cabinet or enclosure ground via an earth ground wire bonded to the ground rod and buried at the site. Multiple inter-connected ground rods provide increased ground electrode-to-earth conductivity (ground grid). You can add supplemental ground rods to a single ground grid in several arrangements, including a linear chain, fan array, or ring configuration. Refer to the NEC or local regulations for restrictions and details. All bonds to grounding electrodes must be suitable for direct burial using irreversible mechanical connections or exothermic welds. Follow local code or site practice to satisfy any additional grounding requirements.
- **Ground ring:** A ground ring consists of multiple ground electrodes that encircle the perimeter of a site. Ground rings represent the preferred earth grounding system for cabinet deployments. Ground rings follow the NEC provisions for multiple ground electrodes.

FieldSmart® Fiber Active Cabinet (FAC) 900 Installation Manual



Example of PANI-compliant ground ring with main site ground buss:

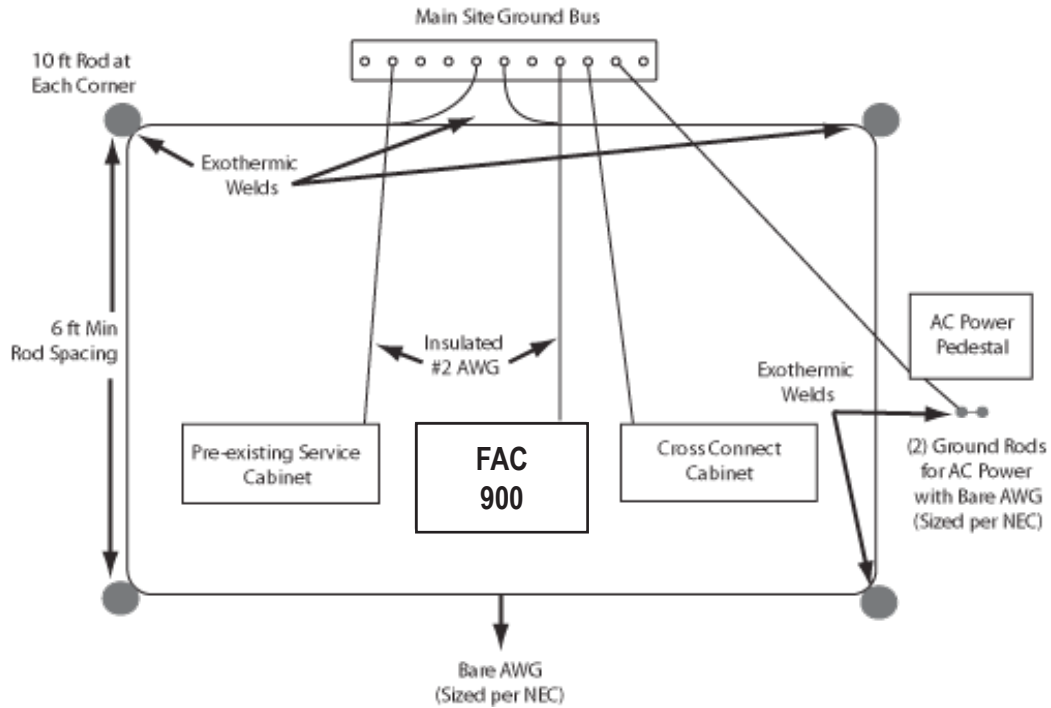

Example of PANI-compliant ground ring without a main site ground buss:

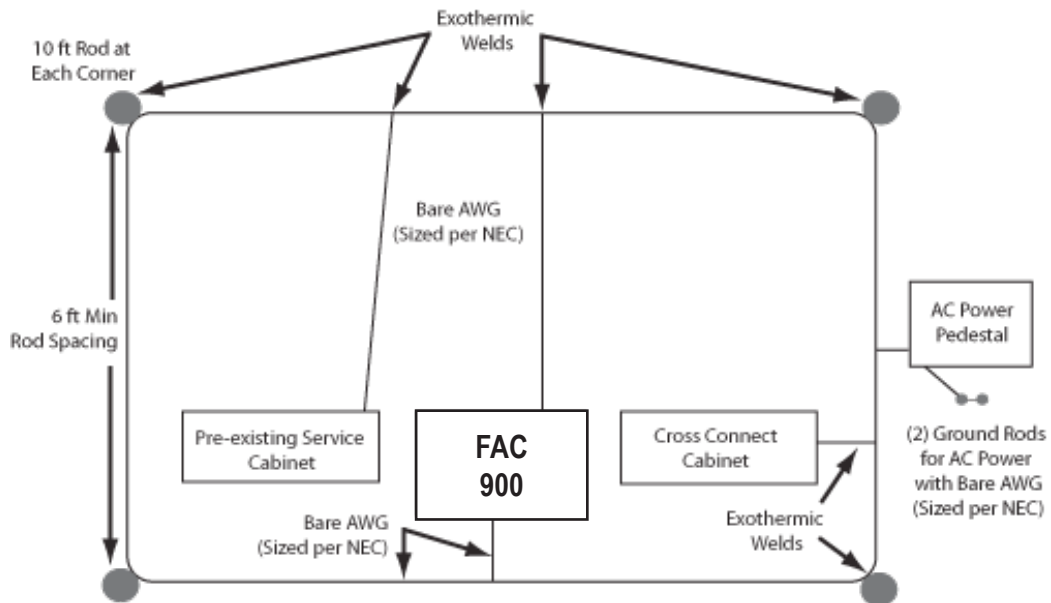



FieldSmart® Fiber Active Cabinet (FAC) 900

Installation Manual

Ground circuit considerations

Following local codes and practices, install a ground circuit at the installation site. Consider the following factors when constructing the ground circuit:

- The ground electrode(s) should be copper-clad steel at least 5/8-inch in diameter.
- The ground rod or pipe electrode(s) should have a minimum of 8 feet of direct contact with earth.
- The wire connecting multiple electrodes should be bare copper sized per NEC, and should be buried at least 30 inches deep or below the frost line (whichever depth is greater).
- The wire connecting multiple electrodes should be connected with an exothermic weld or irreversible mechanical connector suitable for direct burial.
- The wire connecting the cabinet main ground bar to the initial ground electrode should be a 6 AWG or larger bare copper ground wire.
- The ground wire should enter the cabinet separated from power or copper transmission cables. Never bundle the ground wire together with other copper cables.
- Connect the ground wire to the main ground bar.
- Follow the PANI organization for all connections made to the Clearfield equipment cabinet/enclosure ground bar as shown in Clearfield documentation.
- Measurements of the site ground circuit should be conducted to gauge achievement of 5 Ohms or less.

Note: You must install the cabinet's connection to the earth ground circuit before you connect commercial power to the cabinet.

Environmental factors

Environmental factors that may affect grounding conditions include:

- Type and size of an electrical surge; a lightning-induced current surge, voltage spike during an electrical storm, or static build-up from power utility lines may overwhelm the earth ground.
- Wet soil provides low resistance ground, with resistance increasing as the soil dries. Rock, gravel, sand, loam and clay react differently to wet/dry conditions.

Follow local code to satisfy additional requirements, if applicable.

FieldSmart® Fiber Active Cabinet (FAC) 900

Installation Manual



Constructing a Concrete Pad

A concrete pad provides a permanent foundation to anchor the cabinet to the ground while protecting the cabinet from water damage and other outdoor surface conditions.

Construct a concrete foundation pad for the cabinet at the installation site. Pad construction requires excavating the site, trenching cable conduit, constructing a form, and casting concrete. Use the Clearfield -supplied cast-in-place template to provide exact locations for the mounting studs that anchor the cabinet to the pad and to provide the cable conduit locations.

Pad Construction Guidelines

When constructing a concrete pad, observe the following guidelines and refer to the pad drawings for guidance.

Guidelines

Follow these guidelines to ensure proper pad construction. Adjust for local conditions or practices as required.

- Construct a pad for a stand-alone FAC 900 cabinet configuration with minimum perimeter dimensions of 48 x 72 inches.

Note: Be sure to construct an adequate size pad if you may consider adding an EXM later as an expansion.

- Construct a pad for an FAC 900 in-line configuration with minimum dimensions of 48 x 101 inches.
- Construct a pad for an FAC 900 L-configuration with minimum dimensions of 77.5 x 99 inches.

Note: Refer to Space Requirements for more information on cabinet configurations.

- For a pad that includes an EXM, the location of the EXM conduit box is relative to the FAC 900 cast-in-place template.
- Construct the pad with a minimum height of 6 inches.
- Construct the pad with a maximum of 2 inches above-grade exposure.
- Use the Clearfield cast-in-place template to provide exact mounting stud and conduit locations.
- Use rebar or wire mesh inside the form to improve pad strength.
- Cast the pad from a single concrete pour. Do not make multiple pours.
- Ensure that the pad is smooth and level across its entire surface.
- Use 4-inch conduit (maximum) for outside plant cables. See drawings below for entry locations.
- Use 2-inch conduit (maximum) for AC cable (local power applications only). See drawings below for entry location.
- Include pull cords in all cable conduits.



FieldSmart® Fiber Active Cabinet (FAC) 900

Installation Manual

Pad Drawings

Use the following drawings for reference during pad construction.

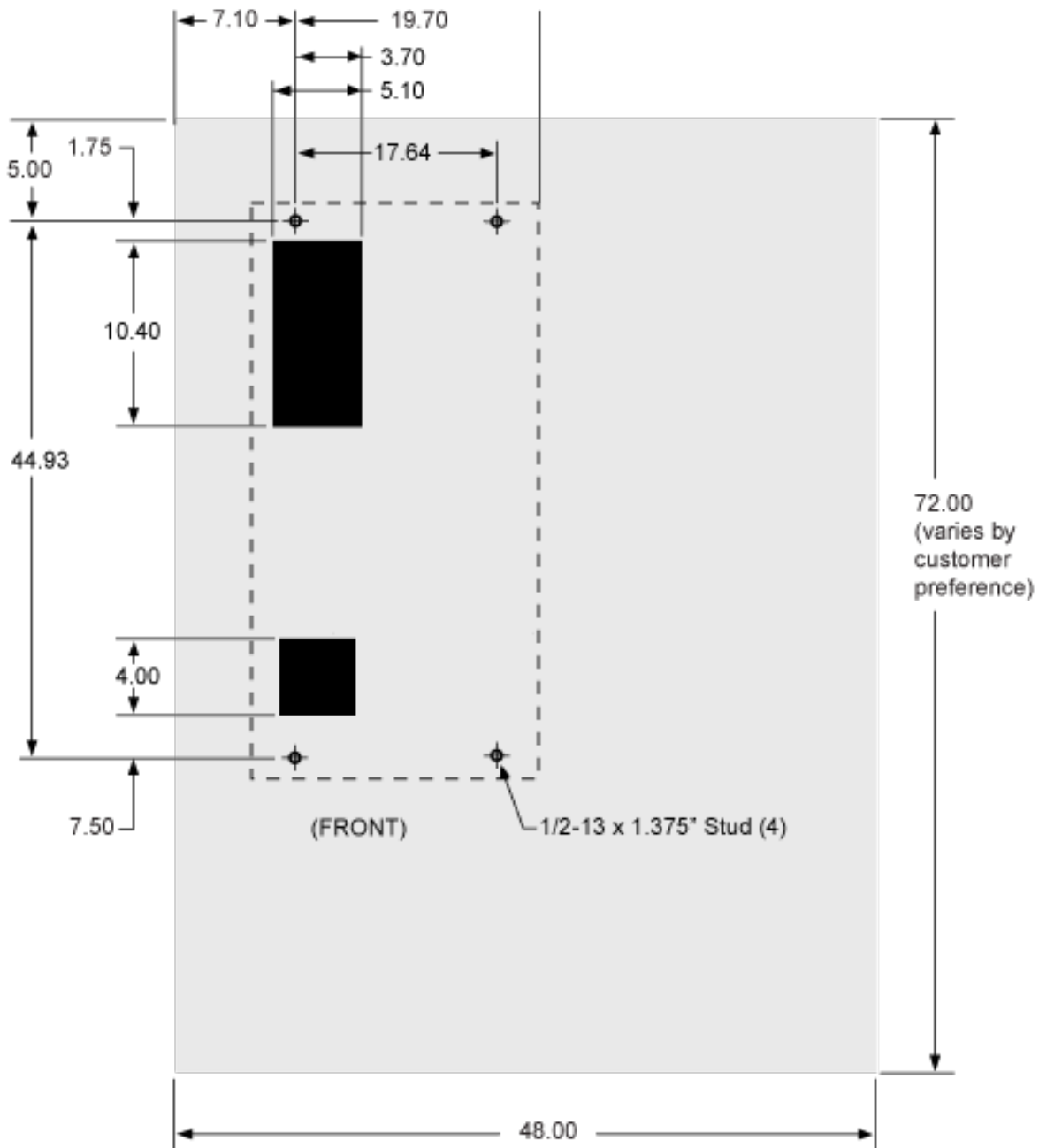

Pad Size: FAC 900 Base Cabinet

FieldSmart® Fiber Active Cabinet (FAC) 900

Installation Manual

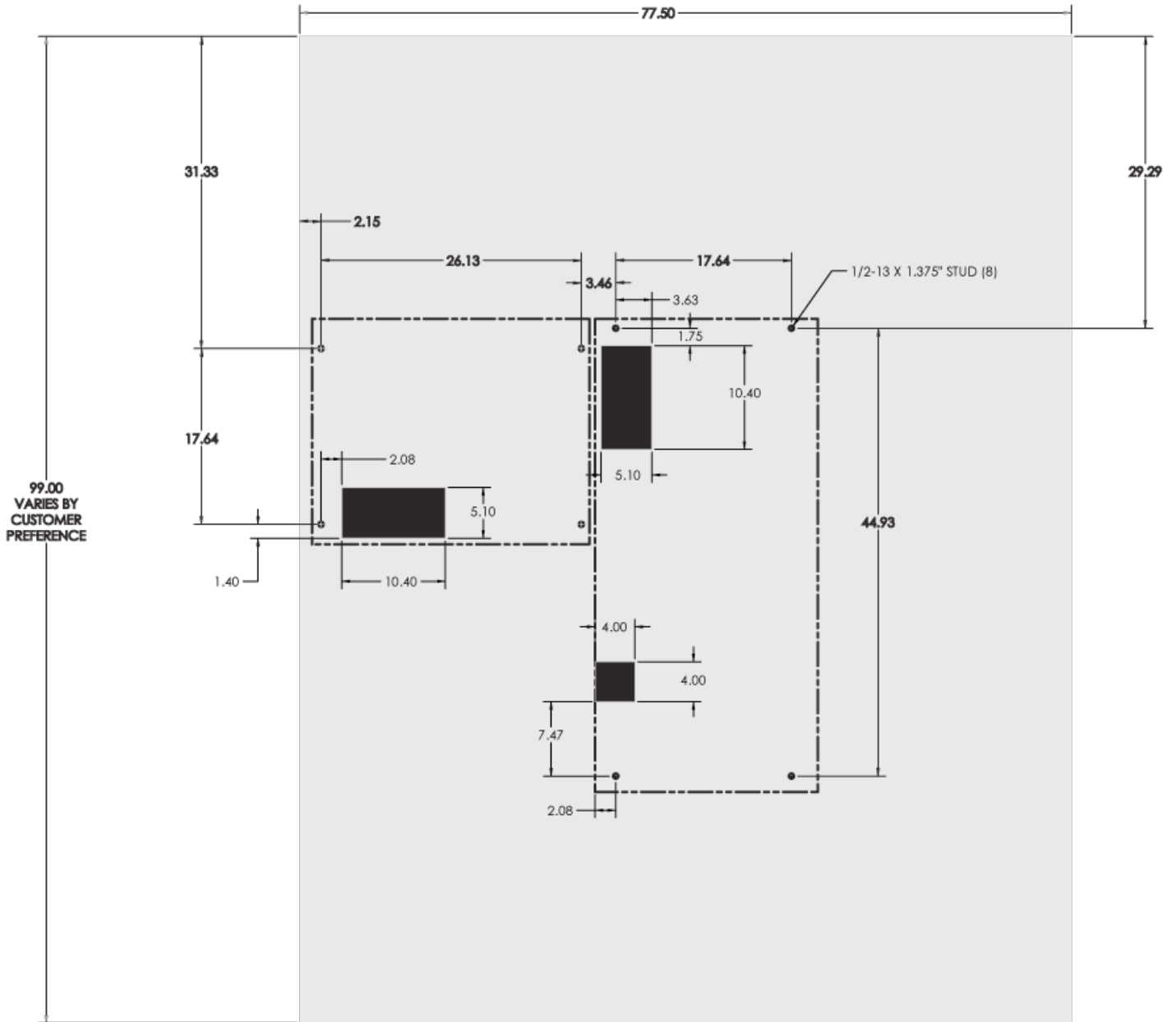

Pad Size: L-Configuration



FieldSmart® Fiber Active Cabinet (FAC) 900

Installation Manual

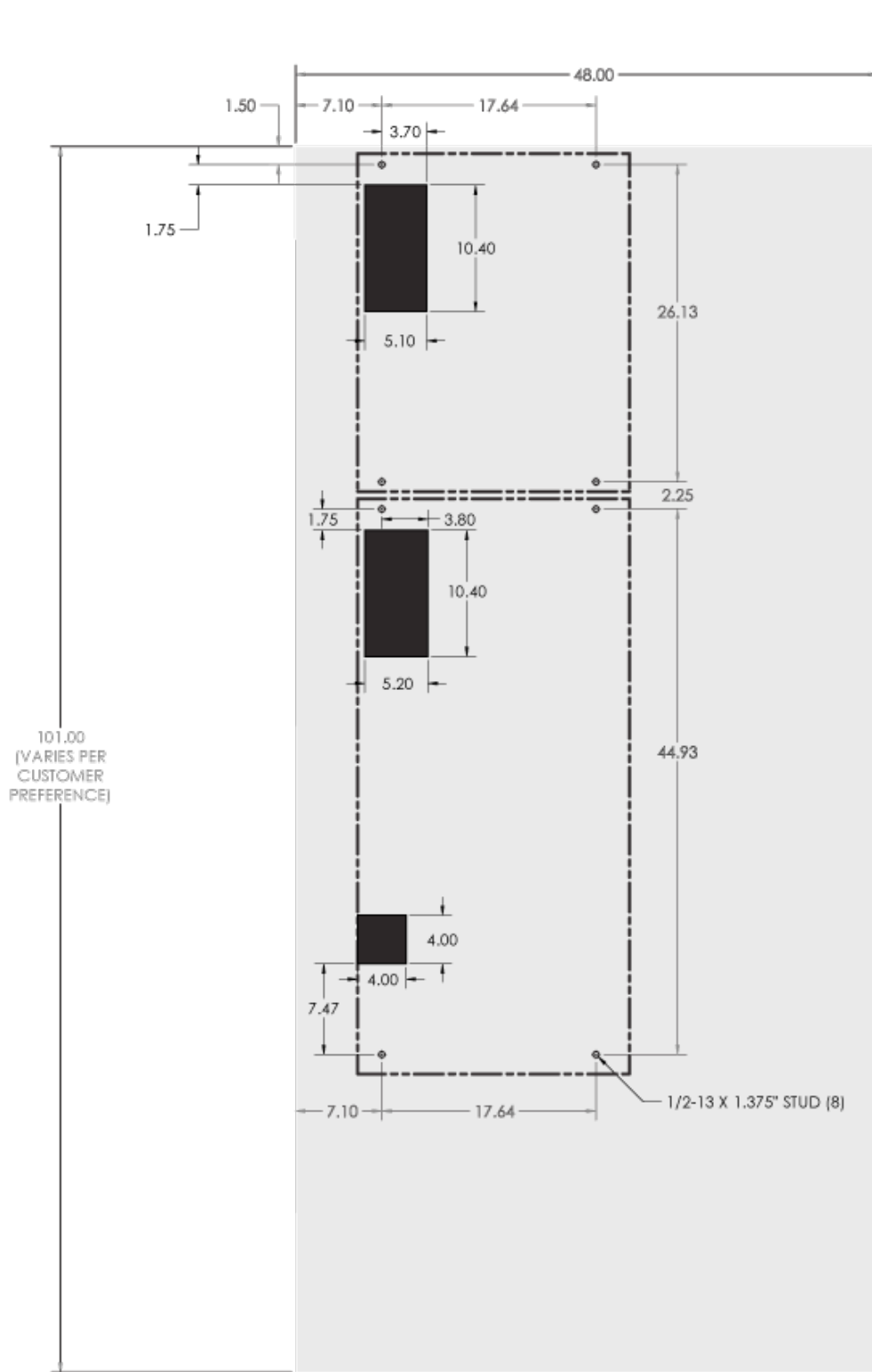

Pad Size: L-Configuration

FieldSmart® Fiber Active Cabinet (FAC) 900

Installation Manual

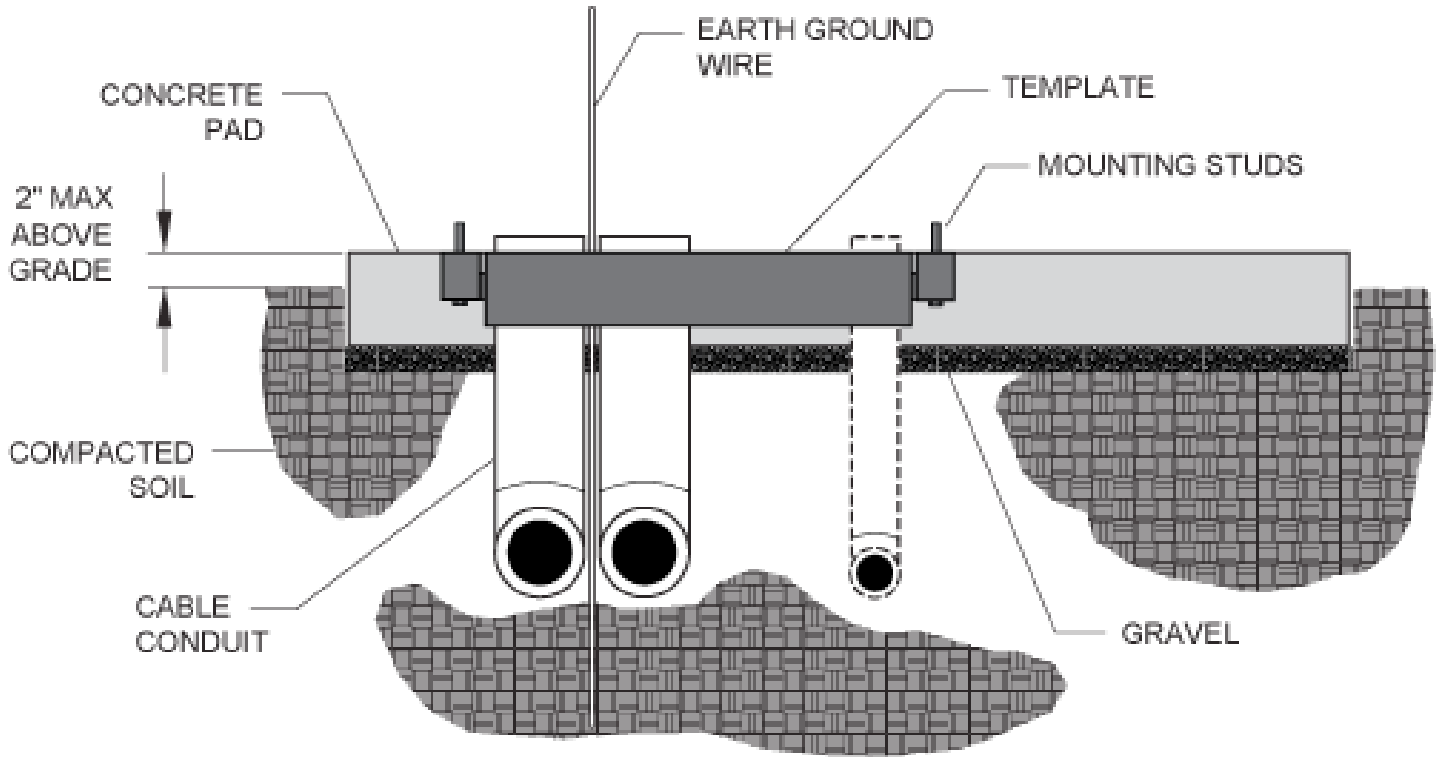

Pad Cross-Section: FAC 900 Base Cabinet
(from left side)



FieldSmart® Fiber Active Cabinet (FAC) 900

Installation Manual

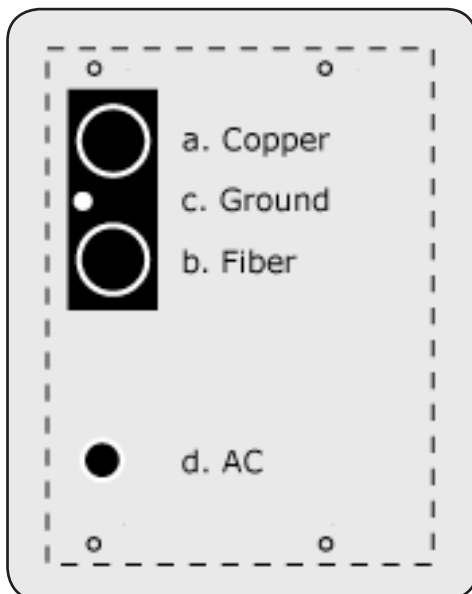
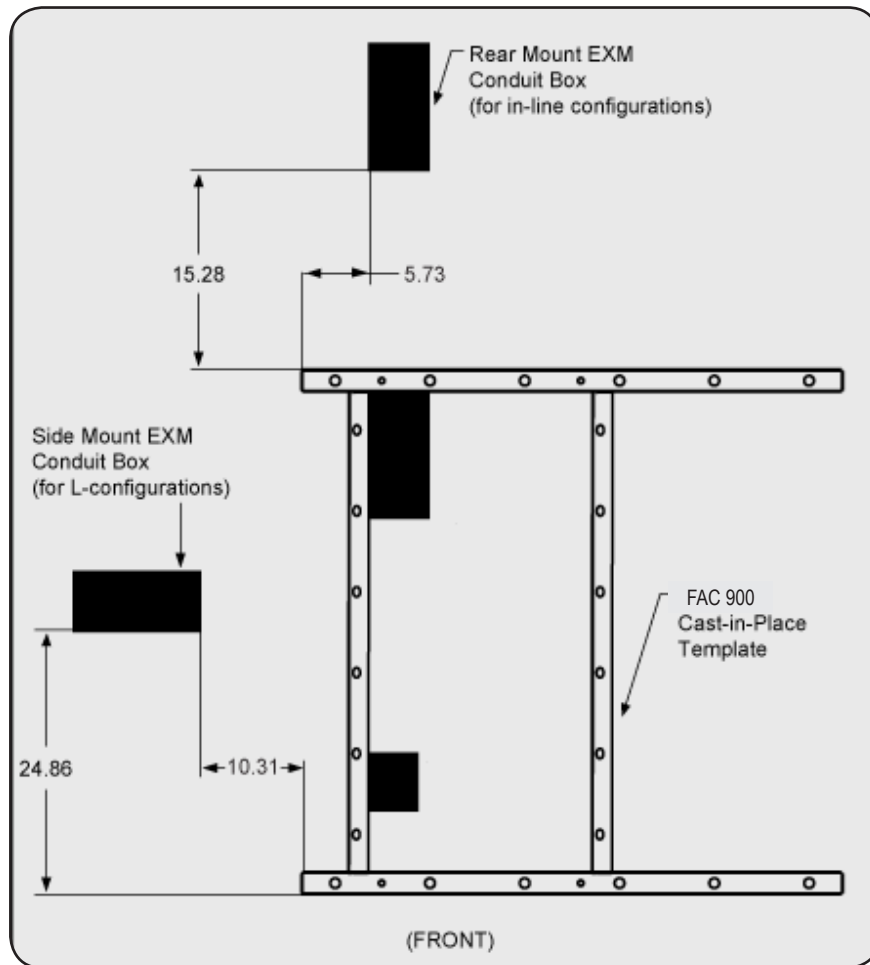

For proper cable entry into the cabinet, place conduit into the following locations.

- Conduit for outside plant cable (copper).
- Conduit for outside plant cable (fiber).
- Earth ground wire.
- Conduit for AC cable (for local power configurations only).

Use the Clearfield cast-in-place template to provide precise conduit orientation.

FieldSmart® Fiber Active Cabinet (FAC) 900

Installation Manual



Assembling the Cast-In-Place Template

Assemble the Clearfield cast-in-place template as follows.

To assemble the template

Step 1: Unpack the template hardware from the shipping kit.

Step 2: Place the four bracket members on the ground, arranged as follows:

- a. Place the two long brackets parallel with each other, flat side down.
- b. Place the two short brackets between (and perpendicular to) the long members, flat side down, with the conduit entry box bracket on the left.

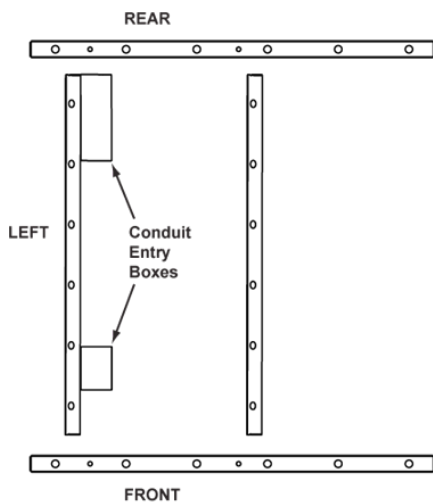

Step 3: Attach the short and long brackets together using eight supplied screws and nuts, as shown.

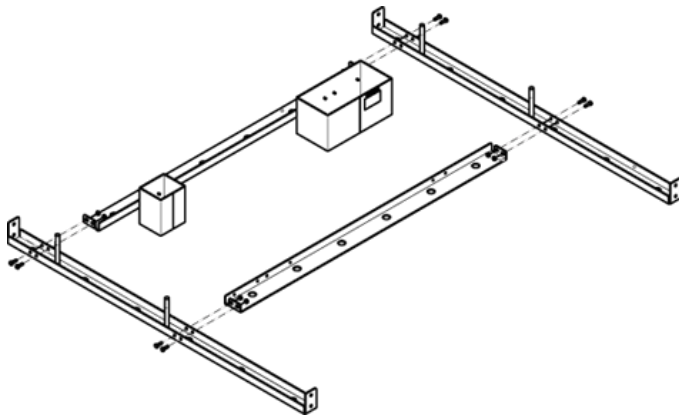

Step 4: Tighten all screws to complete the template assembly.



FieldSmart® Fiber Active Cabinet (FAC) 900

Installation Manual

Preparing the Site

Prepare the site for pad construction as described below. Adapt the instructions as needed for local requirements, practices, or conditions.

To excavate the site

- Step 1:** Excavate the pad area. Dig a foundation hole six inches deep with a perimeter measuring **at least** 48 x 72 inches. Refer to *Space Requirements* for more information.
- Step 2:** Grade and compact the excavated surface until it is firm and level.
- Step 3:** Trench out conduit paths through the foundation hole from the cable feeder location. Refer to the *pad drawings* for conduit locations.
- Step 4:** Place the cable conduits into the conduit trench. Refer to the *pad construction guidelines* for conduit sizes and locations.
- Step 5:** Route the earth ground wire through the conduit trench (from the ground electrode).

To construct a concrete form

- Step 1:** Using 2 x 6 boards and stakes, construct a concrete form with minimum interior dimensions of 48 x 72 inches. Make sure that the top edge of the form is level. Refer to *Space Requirements*.
- Step 2:** Place gravel into the foundation hole to create a level base. The gravel layer should be at least two inches deep, compacted and leveled.
- Step 3:** Place and tie rebar inside the form elevated above the gravel.
- Step 4:** Place the Clearfield cast-in-place template into the form, guiding the cable conduits through the conduit entry ducts in the template.
- Step 5:** Align the template mounting brackets flush with the top of the form, and then nail the template to the form to secure it in place.
Note: *The mounting studs should protrude approximately 1 3/8-inches above the form.*
- Step 6:** Verify that the form remains level across the entire surface. Adjust as required.
- Step 7:** Pull the earth ground wire (from the conduit trench) through the entry duct in the template, allowing at least three feet of wire to extend above the top of the form.
- Step 8:** Mask the four mounting studs on the template to protect the threads from concrete.

FieldSmart® Fiber Active Cabinet (FAC) 900

Installation Manual



Casting the Pad

Cast the concrete foundation pad as described below. Adapt the instructions as needed for local requirements, practices, or conditions.

To cast the concrete pad

Step 1: Prepare the concrete mix. Be sure to mix enough concrete to cast the entire pad in a single pour.

Note: *To avoid structural weakening, do not cast a pad from multiple concrete pours.*

Step 2: Pour the concrete into the form. Do not allow the cast-in-place template to bend or twist out of shape during the pour.

Step 3: Smooth and level the top surface of the concrete.

Step 4: Leave the pad to cure. Do not remove the form until the concrete has fully cured (at least 72 hours).

Perform the remaining steps only after the concrete has cured.

Step 5: Remove and discard the form.

Step 6: Backfill the cable conduit trenches with soil or gravel as required.

Step 7: Backfill and grade the perimeter area around the pad with soil, as required.

Step 8: Trim the cable conduits to a height no more than 4 inches above the pad.



FieldSmart® Fiber Active Cabinet (FAC) 900

Installation Manual

Installing a Pre-Cast Concrete Pad

A concrete pad provides a permanent foundation to anchor the cabinet to the ground while protecting the cabinet from water damage and other outdoor surface conditions.

Install a pre-cast concrete pad for the cabinet at the installation site. Installation requires excavating the site, trenching cable conduit, creating a gravel foundation base, and installing the pre-cast pad.

Pre-cast pads typically ship configured with conduit entry cutouts and mounting fixtures (anchor studs or countersunk threaded inserts) for anchoring the cabinet to the pad. Specific features and dimensions vary by manufacturer. Contact your sales representative for a list of Clearfield -certified suppliers to contact directly.

Preparing the Site

Prepare the site for installation of a pre-cast pad according to the manufacturer's instructions. Some pads may require custom preparations.

A general practice is described below for reference. Adapt the instructions as needed for local requirements, practices, or conditions.



DANGER! Do not place outside plant cables into conduits at the pad site before installing the pre-cast pad. Attempting to install a pre-cast pad over existing cables becomes hazardous if a person must reach underneath a lowered pad to feed cables through its entry cutout.

To prepare the site for pad installation

- Step 1:** Excavate the pad area. Dig a foundation hole six inches deep with a perimeter measuring at least 48 x 72 inches; dimensions may vary based on manufacturing requirements and the selected FAC 900 configuration.
- Step 2:** Grade and compact the excavated surface until it is firm and level.
- Step 3:** Trench out conduit paths through the foundation hole from the cable feeder location.
- Step 4:** Place the cable conduits into the conduit trench.
- Step 5:** Route the earth ground wire through the conduit trench (from the ground electrode).
- Step 6:** Place gravel into the foundation hole to create a level base. The gravel layer should be at least two inches deep, compacted and leveled.

Note: When installed, the pad should stand at least one inch above grade. Adjust the compaction and gravel depth accordingly, based on the pad height.

FieldSmart® Fiber Active Cabinet (FAC) 900

Installation Manual



Installing a Pre-Cast Pad

Install the pre-cast pad according to the manufacturer's instructions (typically supplied with the pad).

A general installation practice is described below for reference. Adapt the instructions as needed for local requirements, practices, or conditions.



WARNING! The pre-cast concrete pad is extremely heavy. Do not place any part of your body under the pad during lifting. Handle with care to avoid personal injury or damage to the pad.

To install a pre-cast pad

- Step 1:** Transport the pre-cast pad to installation site.
- Step 2:** Using a suitable lifting device (such as a backhoe equipped with lifting slings), lift the pad into position above the gravel base inside the foundation hole.
- Step 3:** Lower the pad onto the gravel base, allowing the conduits to pass through the cutout in the pad as it descends.
- Step 4:** Adjust the pad positioning on the gravel base until it is stable and level.
- Step 5:** Pull the earth ground wire through the cutout in the pad, allowing at least four feet of wire to extend above the top of the pad.
- Step 6:** Backfill and grade around the pad perimeter with soil to secure the pad in place.
- Step 7:** Verify that the pad remains level. Adjust as required.
- Step 8:** Trim the cable conduits to a height no more than 4 inches above the pad.



FieldSmart® Fiber Active Cabinet (FAC) 900

Installation Manual

Installing a Wall/H-Frame Mount Kit

A sturdy, plumb wall or H-frame can provide an effective mounting structure for elevating the cabinet above the ground, particularly in areas subject to severe surface conditions such as flooding, mud, or heavy snow. Wall/H-frame mounting also allows cabinets to be installed in locations where the required terrestrial right-of-way may be unavailable.

Use the Clearfield wall-mount kit to provide the mounting fixture. The wall/H-Frame mount kit consists of mounting brackets that attach directly to a wall or H-frame and a conduit feedthru assembly which provides exact entry locations for cable conduits.

You can install the mounting kit onto an existing wall, or you can construct an H-frame at the installation site to support the cabinet. Installing the wall/H-frame mount kit requires trenching cable conduit to the site and installing the mounting kit on the wall or H-frame.

Wall/H-Frame Mounting Configurations and Drawings

Clearfield supports the following wall and H-frame mounting configurations:

- **FAC 900 low profile**
- **FAC 900 + EXM low profile**
- **FAC 900 high profile**
- **FAC 900 + EXM high profile**

High profile configurations include a space allowance for a splice blister mounted on the rear of the enclosure(s), and low profile configurations do not include this space allowance.

Drawings

Use the following drawings for reference during site preparation. Wall dimensions may vary by site. Defer to local practice where required.

Note: *The low profile and high profile mounting dimensions (shown in inches) account for configurations with or without an EXM.*

FieldSmart® Fiber Active Cabinet (FAC) 900

Installation Manual

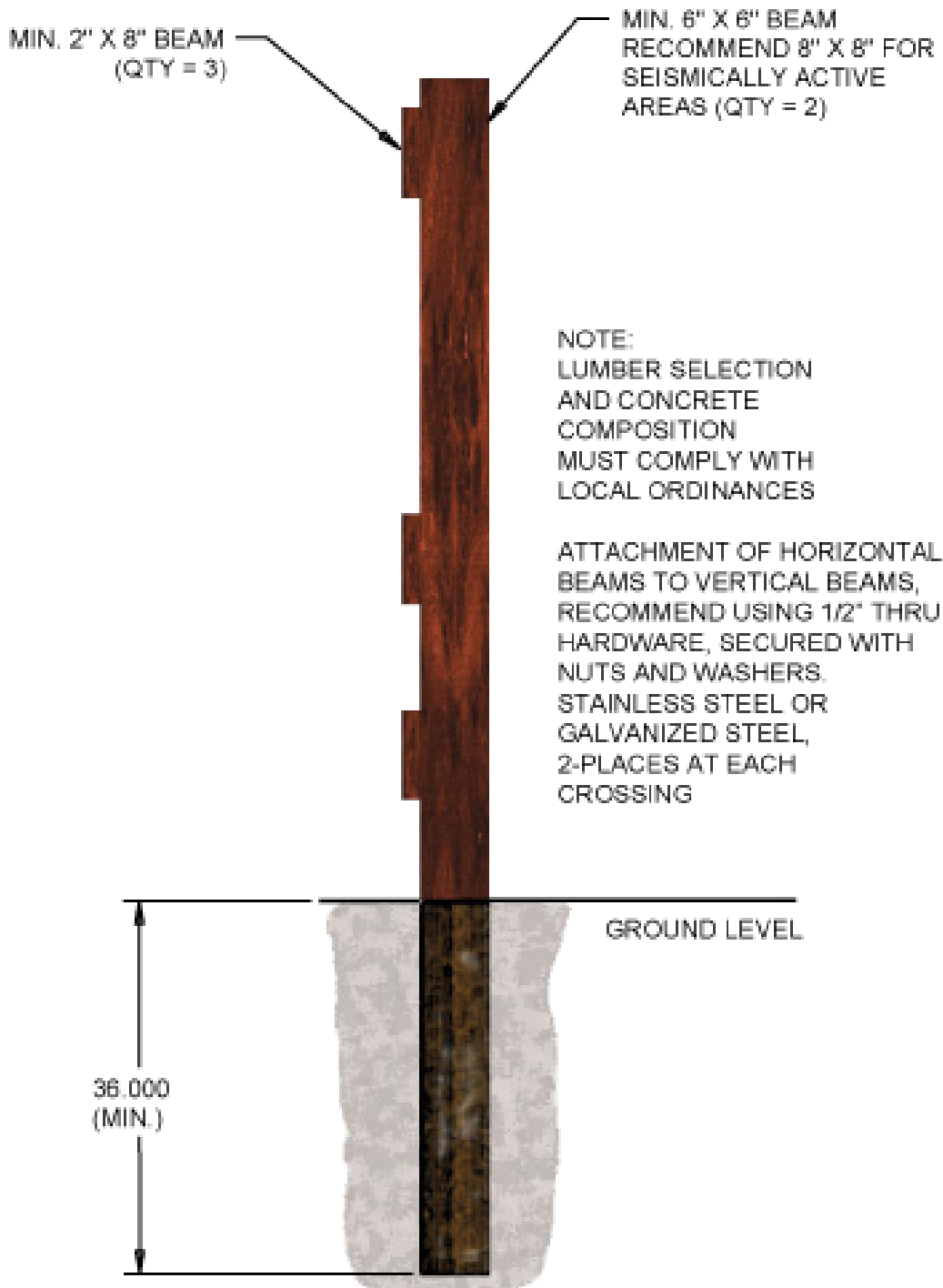

H-Frame Mount: Side View



FieldSmart® Fiber Active Cabinet (FAC) 900

Installation Manual

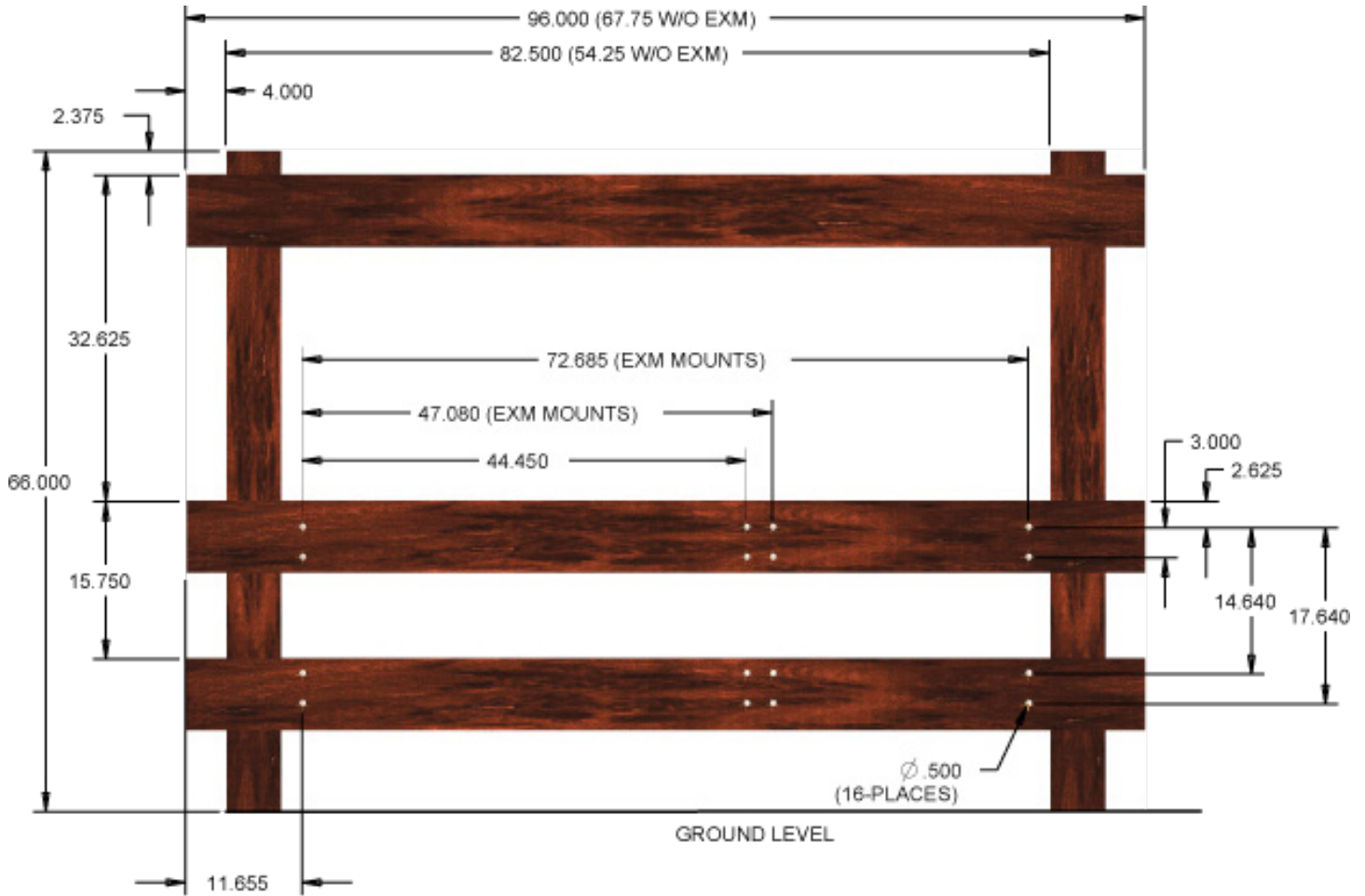

Wall/H-Frame Mount Dimensions: Low Profile Configurations
(No splice blister allowance on backside)

FieldSmart® Fiber Active Cabinet (FAC) 900

Installation Manual

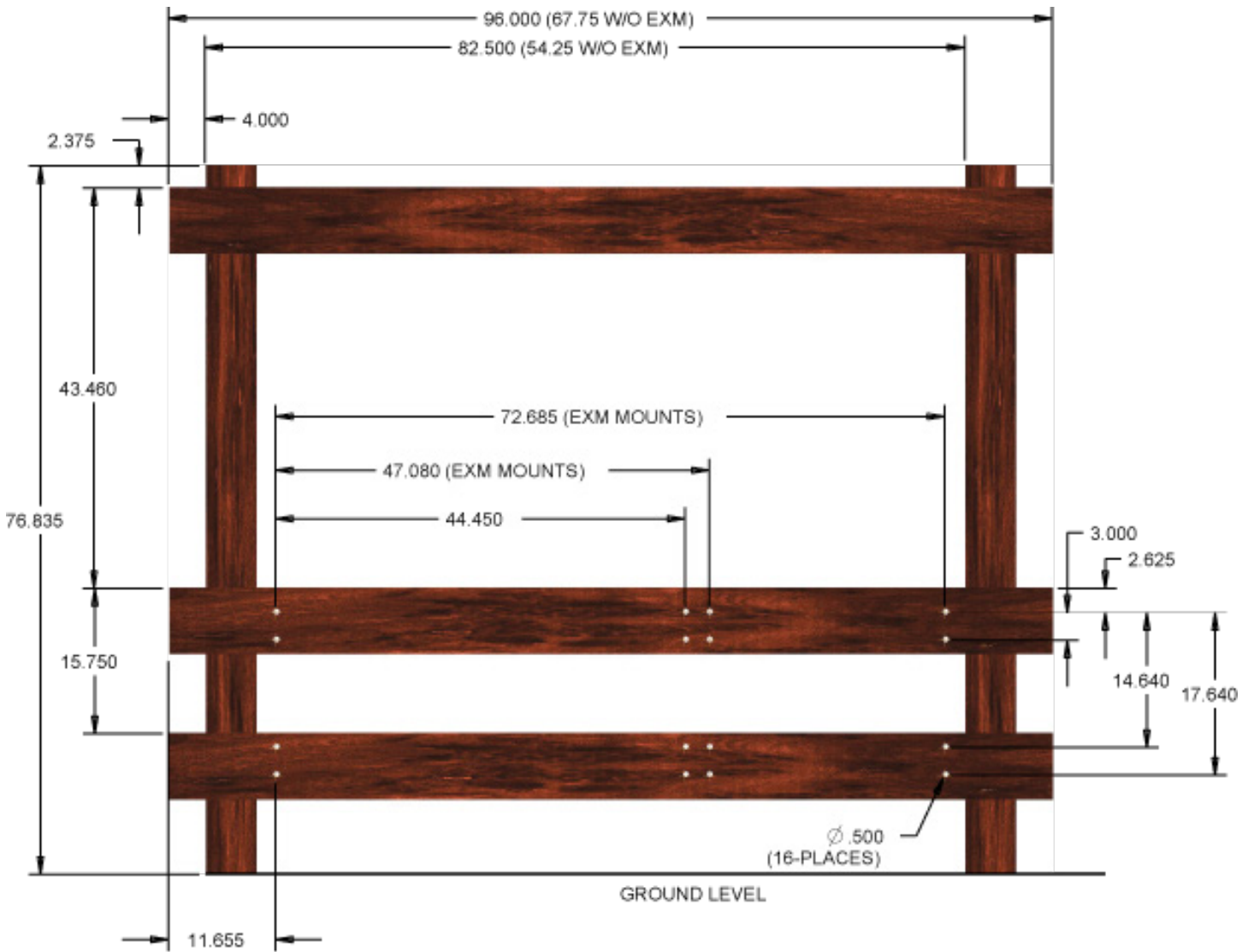

Wall/H-Frame Mount Dimensions: High Profile Configurations
(Allowance for splice blister on backside)



FieldSmart® Fiber Active Cabinet (FAC) 900

Installation Manual

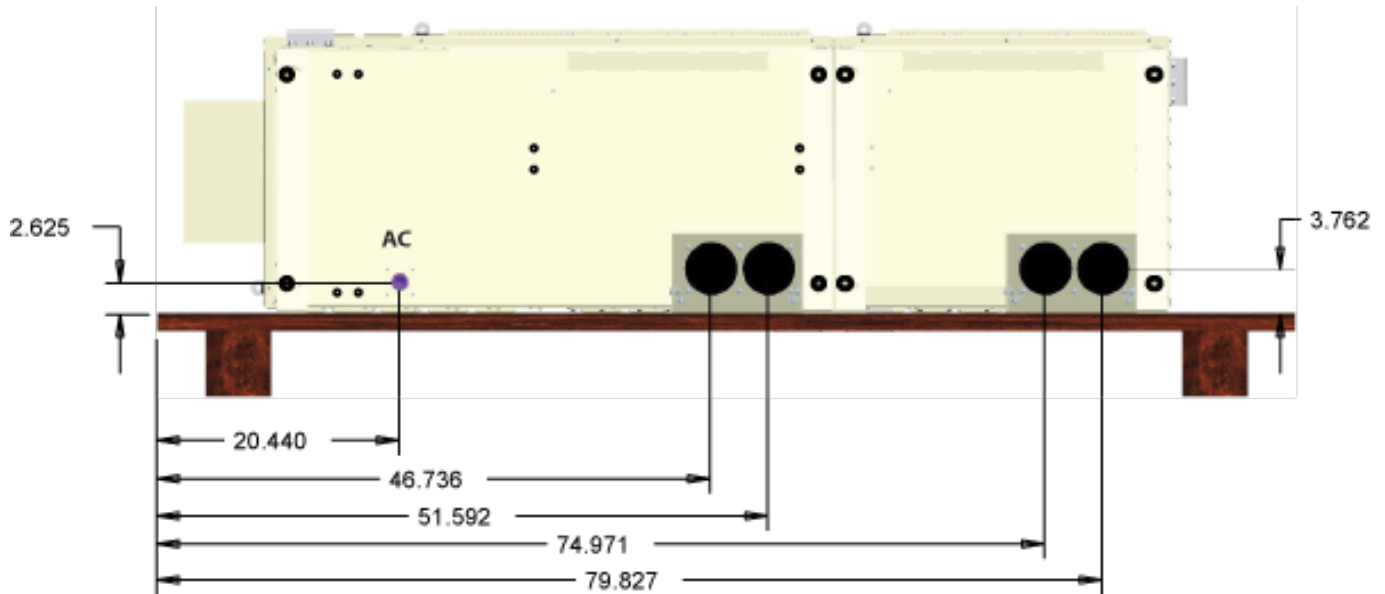

Conduit Locations
(as viewed from bottom)

Wall/H-Frame Mounting Guidelines

When installing the wall/H-frame mount kit, observe the following guidelines. Refer to the *wall/H-frame configurations and drawings* for guidance.

Guidelines

Follow these guidelines to ensure proper mounting support for the cabinet and EXM. Adjust for local conditions or practices as required.

- The wall/H-frame must be vertically plumb.
- The wall/H-Frame must support a minimum load weight, as follows:
 - **FAC 900 only:** 730 lbs
 - **FAC 900 + EXM:** 880 lbs

Note: These weights include fully loaded enclosures, with a single battery string.

- The top of the base platform must be a minimum of 15.25 inches above the ground.
- The wall or H-frame must stand a minimum height above the ground, as required for the cabinet mounting configuration:
 - **Low profile configurations:** The wall or H-frame must stand at least 66 inches above ground.
 - **High profile configurations:** The wall or H-frame must stand at least 76.835 inches above ground.

FieldSmart® Fiber Active Cabinet (FAC) 900

Installation Manual



Note: The minimum heights assume a distance of 15.25 inches above the ground to the top of the base platform. To elevate the cabinet higher than 15.25 inches above ground, use a wall or H-frame with sufficient additional height.

- Use the Clearfield wall/H-frame mount kit to provide the mounting fixture and conduit entry locations.
- The Clearfield wall/H-frame mount kit provides assembly hardware for a wall or wooden H-frame, however *you must provide the hardware* to attach the mounting fixture, as appropriate for your site requirements. For example, attaching the fixture to a concrete wall requires different hardware (anchors). Follow local codes and practices to supply the required mounting hardware.
- Use 4-inch conduit (maximum) for outside plant cables. See figure for entry locations.
- Use 2.5-inch conduit (maximum) for AC cable. See figure for entry location.
- Include pull cords in all cable conduits.
- For H-frames, Clearfield recommends the following *nominal* beam sizes, as required for the cabinet mounting configuration:
 - **Low profile configurations:** Two 6" x 6" x 8.5' vertical beams, or two 8" x 8" x 8.5' vertical beams for seismically active areas
 - **High profile configurations:** Two 6" x 6" x 9.4' vertical beams, or two 8" x 8" x 9.4' vertical beams for seismically active areas
 - **(FAC 900 + EXM) Both low and high profile configurations:** One 2" x 8" x 8.0' horizontal beams on the top and two 2" x 8" x 8.0' horizontal beams on the bottom to support the fixture

Note: To use the supplied hardware, do not exceed the nominal size for the horizontal beams. A nominal size of 2" x 8" x 8.0' correlates to an actual size of 1.5" x 7.25" x 8.0'.

- **(FAC 900 only) Both low and high profile configurations:** One 2" x 8" x 5.6' horizontal beams on the top and two 2" x 8" x 5.6' horizontal beams on the bottom to support the fixture

Preparing the Site

Prepare the site for installation of a wall/H-frame mount kit. A general practice is described below for reference. Adapt the instructions as needed for local requirements, practices, or conditions.

To prepare the site for a wall/H-frame mount installation

- Step 1:** At the installation site, verify the following:
- The wall or H-frame is installed and plumb.
 - The wall or H-frame meets the cabinet mounting *requirements*.
- Step 2:** Trench out conduit paths to the wall or H-frame from the cable feeder location. Place the cable conduits into the conduit trench. At the wall or H-frame, allow the conduit to extend above ground to the approximate height of the base platform. Refer to the *wall mounting guidelines* and *drawings* for conduit locations.
- Step 3:** Route the earth ground wire through the conduit trench (from the ground electrode). Pull six feet of wire above ground and position it adjacent to the wall or H-frame. Backfill the conduit trench with soil.



FieldSmart® Fiber Active Cabinet (FAC) 900

Installation Manual

Installing the Wall/H-Frame Mounting Fixture

This topic describes how to install the wall/H-frame mounting brackets and conduit feed through assembly.

To install the wall/H-frame mounting fixture

Step 1: Attach the mounting brackets to the wall/H-frame horizontal beams as follows:

- a. Mark (4) pilot hole locations on the horizontal beams based on your selected configuration. See *Wall/H-Frame Mounting Configurations and Drawings* for exact locations of pilot holes.
- b. Drill 3/8-inch pilot holes into the horizontal beams at the marked locations.
- c. Position the bracket against the wall/H-frame, as shown in the illustration below:
 - Orient the bracket facing inward, with mounting slots against the wall/H-frame and on the top.
 - Align the top of the mounting bracket flush to the top edge of the middle horizontal beam, and center the mounting slots on the drilled holes in the beam.

Note: You can offset the horizontal position of the brackets later if needed, once the cabinet is roughly positioned.

- d. Install (1) 1/2"-13 x 3.00" hex screw, 1/2" split lock washer and 1/2" flat washer to attach the mounting bracket to the front of the wall/H-frame.
- e. On the back side of the wall/H-frame, install (1) 1/2"-13 hex nut, 1/2" split lock washer and 1/2" flat washer.
- f. Verify that the bracket is level, and then tighten the hardware to secure the bracket in place.
- g. Repeat steps 1a–1f to install additional mounting brackets.

Step 2: (For FAC 900 + EXM configurations only) Secure the two center mounting brackets together as follows:

- a. From the left side of the brackets, install (1) 1/2"-13 x 1.25" hex screw, 1/2" split lock washer and 1/2" flat washer.
- b. On the right side of the brackets, install (1) 1/2"-13 hex nut, 1/2" split lock washer and 1/2" flat washer.

FieldSmart® Fiber Active Cabinet (FAC) 900

Installation Manual

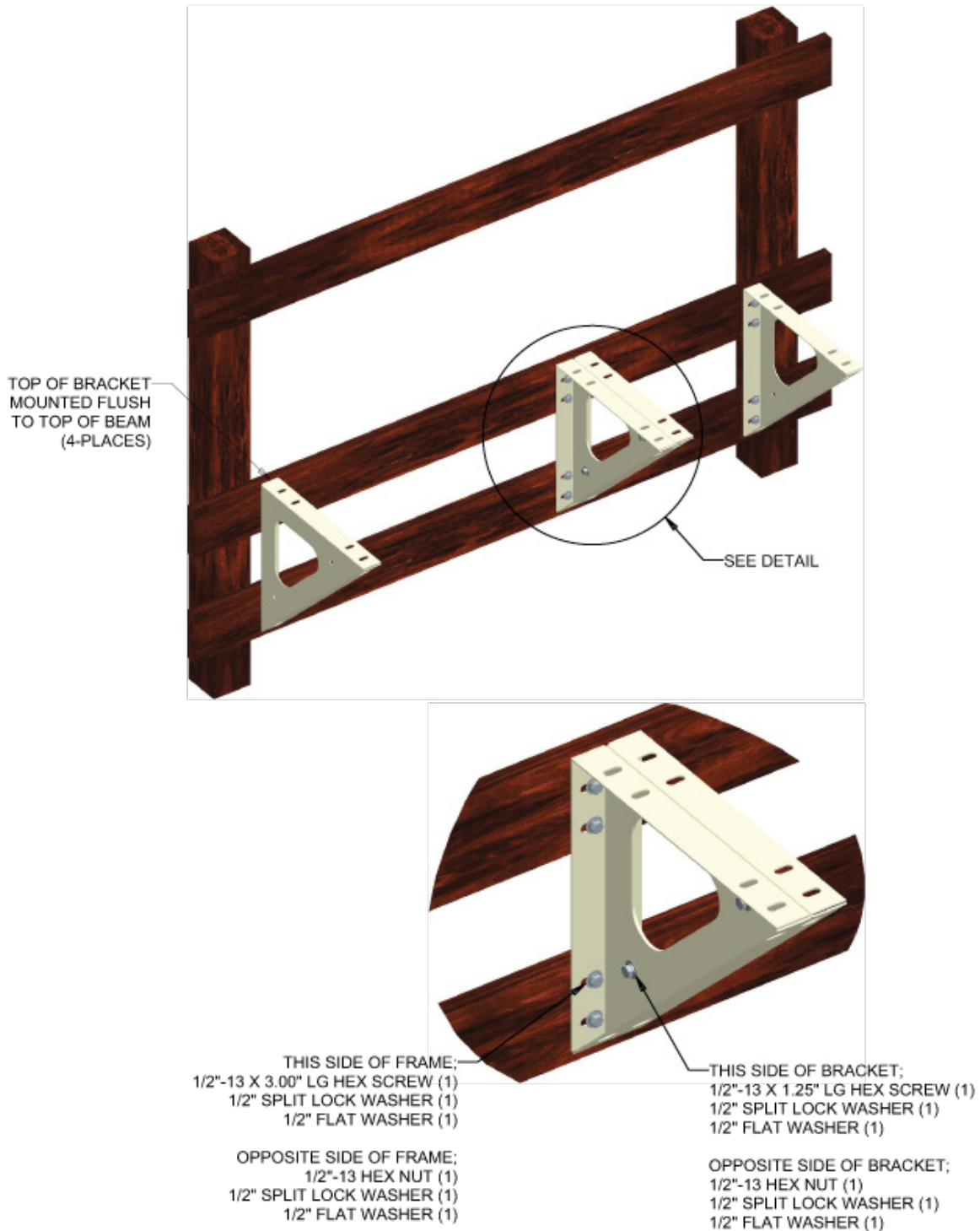



FieldSmart® Fiber Active Cabinet (FAC) 900

Installation Manual

Step 3: Attach the conduit feed through assembly to the wall/H-frame as follows:

- Position the feed throughs flush to the top edge of the middle horizontal beam, with the right edge of the assembly mated to the left side of the mounting bracket as shown in the illustration below.
- Hold the conduit assembly in place with c-clamps and drill 1/8" pilot holes into the beam through the assembly mounting slots.
- Install (1) 3/8 x 1.50 LAG screw, 3/8" split lock washer and 3/8" flat washer to attach the assembly to the front of the wall/H-frame.
- For FAC 900 + EXM configurations, repeat steps 3a–3c to attach a second conduit feed through assembly.

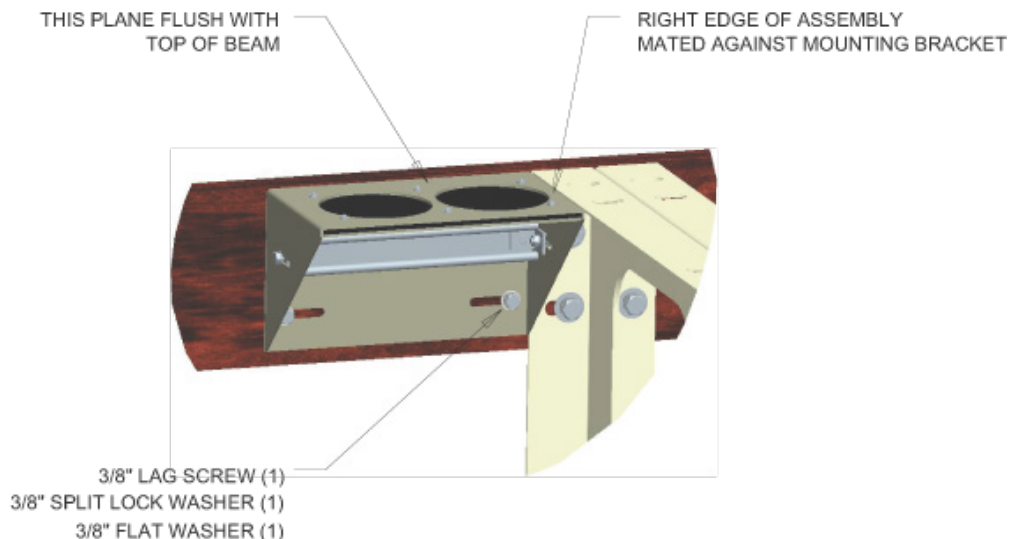

FieldSmart® Fiber Active Cabinet (FAC) 900

Installation Manual



Installing the Stabilizer Bracket(s)

This topic describes how to install stabilizer brackets on the FAC 900 and EXM. The bracket(s) is required for an H-frame mounting.

To install stabilizer bracket(s) for an H-frame

- Step 1:** Position the stabilizer bracket against the rear enclosure wall in the location where you removed the lifting detail, aligning the (2) bracket holes with the counterpart holes in the cabinet. For low profile configurations the (2) bracket holes are on top; for high profile configurations the (2) bracket holes are on the bottom (as shown in the illustration below).
- Step 2:** Reinstall the hardware set aside from the lifting detail to secure the bracket to the cabinet.
- Step 3:** Drill (4) 1/8" pilot holes into the top horizontal beam through the bracket holes.
- Step 4:** Install (4) 3/8 x 1.50 LAG screws, 3/8" split lock washers and 3/8" flat washers to attach the bracket to the H-frame.

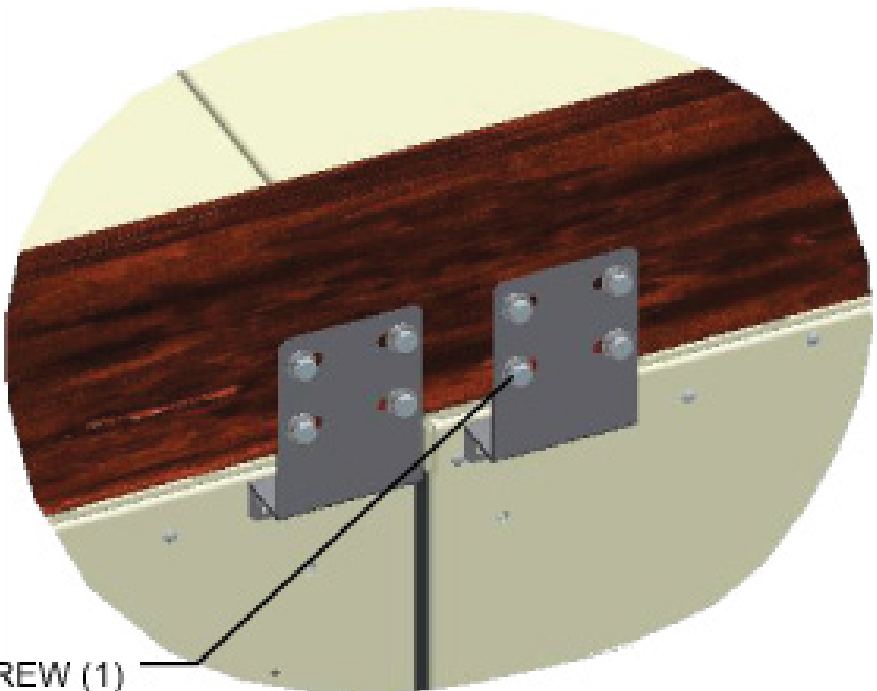

- 3/8" LAG SCREW (1)
- 3/8" SPLIT LOCK WASHER (1)
- 3/8" FLAT WASHER (1)



FieldSmart® Fiber Active Cabinet (FAC) 900

Installation Manual

Installing a Foundation Vault

A foundation vault constructed of composite materials provides a flexible cabinet mounting option. Because foundation vaults stand approximately three feet tall, you can either bury the vault below ground to provide a pad-like mounting fixture with underneath access for maintenance and splice case storage, or you can install the vault above ground to serve as a riser in areas subject to heavy snow, mud, or flooding.

Installing a foundation vault requires excavating the installation site, trenching cable conduit, creating a gravel foundation base, and placing the vault on the foundation base.

Foundation vaults ship configured with knockouts for conduit entry and mounting fixtures (threaded inserts) for anchoring the cabinet to the top of the vault. Specific features and dimensions vary by manufacturer and model. Contact your sales representative for Clearfield -certified supplier information to contact directly.

Preparing the Site

Prepare the site for installation of a foundation vault according to the manufacturer's instructions. Some vaults may require custom preparations.

A general practice is described below for reference. Adapt the instructions as needed for local requirements, practices, or conditions.

To prepare the site for foundation vault installation

- Step 1:** Excavate the pad area. Dig a foundation hole to the required depth (six inches deep minimum); perimeter dimensions vary based on manufacturing requirements and selected FAC 900 configuration.
- Step 2:** Grade and compact the excavated surface until it is firm and level.
- Step 3:** Trench out conduit paths through the foundation hole from the cable feeder location.
- Step 4:** Place the cable conduits into the conduit trench.
- Step 5:** Route the earth ground wire through the conduit trench (from the ground electrode).
- Step 6:** Place gravel into the foundation hole to create a level base. The gravel layer should be at least one inch deep, compacted and leveled.

FieldSmart® Fiber Active Cabinet (FAC) 900

Installation Manual



Installing the Foundation Vault

Install the foundation vault according to the manufacturer's instructions (typically supplied with the vault).

A general installation practice is described below for reference. Adapt the instructions as needed for local requirements, practices, or conditions.



WARNING! The foundation vault may be very heavy. Do not place any part of your body under the vault during lifting. Handle with care to avoid personal injury or damage to the vault.

To install a foundation vault

- Step 1:** Transport the foundation vault to installation site.
- Step 2:** Using a suitable lifting device, lift the vault into position above the foundation hole.
- Step 3:** Lower the pad onto the gravel base, making sure the conduits and earth ground wire pass inside the vault as it descends.
- Step 4:** Adjust the vault positioning on the gravel base until it is stable and level.
- Step 5:** Backfill and grade around the vault perimeter with soil to secure it in place.
- Step 6:** Verify that the vault remains level. Adjust as required.



FieldSmart® Fiber Active Cabinet (FAC) 900

Installation Manual

Chapter 4: Installing the Cabinet and Expansion Module

This chapter describes how to install the Clearfield FAC 900 cabinet onto its permanent mounting location.

Topics Covered

This chapter covers the following topics:

- Unpacking the cabinet or Expansion Module (EXM) from its shipping crate.
- Operating the cabinet or EXM doors.
- Preparing the cabinet for installation.
- Preparing the EXM for installation.
- Installing the cabinet or riser onto a concrete pad.
- Installing the EXM (and riser) on a concrete pad.
- Removing the cabinet lifting detail brackets.

FieldSmart® Fiber Active Cabinet (FAC) 900

Installation Manual



Unpacking the Cabinet, Expansion Module or Risers

The cabinet, Expansion Module (EXM) and risers ship from the factory on wooden pallets, and are enclosed in cardboard crating for protection. The cabinet, EXM and risers are secured to a pallet by four bolts.

Do not remove the cabinet, EXM or risers from the pallet until after delivery to the installation site. However, you can remove the cardboard crating to inspect them at the staging area, if required. Clearfield recommends keeping the protective packaging in place for transportation.

When transporting the cabinet, EXM or risers to the installation site, strap them down securely to the truck or trailer to prevent shifting or tipping. Unpack the cabinet, EXM or risers at the installation site.

To unpack the cabinet, EXM or risers

- Step 1:** After the cabinet, EXM or risers have been delivered to the installation site, remove the cardboard packaging from them.
- Step 2:** Review the packing list to verify that all shipped materials are present.
- Step 3:** Discard the packaging material.
- Step 4:** Retrieve the telco hex key tied or taped to (one of) the cabinet or EXM door(s), and unlock the door(s).

Note: See *Operating Cabinet Doors for instructions*.

Do not remove the bolts securing the cabinet, EXM or risers to the pallet until the enclosure is ready for placement.



FieldSmart® Fiber Active Cabinet (FAC) 900

Installation Manual

Operating a Cabinet or Expansion Module Door

Cabinet Doors

The cabinet has hinged front and side doors, each equipped with two telco hex-pin latches and a padlock hasp for security. Open and close doors using a Clearfield -supplied telco hex key.

Each door is equipped with an alarm switch that monitors the position of the door. When a door on an in-service cabinet or EXM is opened, an intrusion alarm reports through the equipment. Pull the switch plunger to disable the alarm reporting while you are working on the cabinet or EXM. The alarm switch is located at the upper right corner of the door frame.

To open a cabinet or EXM door

Step 1: Insert the telco hex key into the door's upper hex-pin latch.



Step 2: Turn the key counter-clockwise to disengage the latch.

Step 3: Repeat Steps 1 and 2 to disengage the lower latch.

Step 4: Swing the door open until the wind brace engages.

Step 5: On a powered cabinet, pull the alarm switch plunger to disable reporting of the intrusion alarm.



Note: Do not rotate the switch plunger. Rotating the plunger may damage the switch.

FieldSmart® Fiber Active Cabinet (FAC) 900

Installation Manual



To close a cabinet or EXM door

Step 1: Push up on the wind brace to disengage it.



Step 2: Swing the door closed.

Step 3: Insert the telco hex key into the door's upper latch.

Step 4: While holding the door firmly closed, turn the key clockwise to engage the latch.

Step 5: Repeat Steps 3 and 4 to engage the lower latch.



FieldSmart® Fiber Active Cabinet (FAC) 900

Installation Manual

Preparing the Cabinet for Installation

Complete the following preparations before installing the cabinet.

To prepare the cabinet for installation

- Step 1:** Open the front and side cabinet doors.
- Step 2:** From the side of the cabinet, remove the isolation mat and the bag containing the installation hardware. Set them aside for use during installation.
- Step 3:** In the front of the cabinet, remove the right AC cover panel as follows:
- Remove the (3) mounting screws securing the cover panel to the fixture.
 - Push up on the (2) lifting tabs, angle the panel away from the fixture, and lift the panel from the (3) capture tabs on the bottom of the fixture.

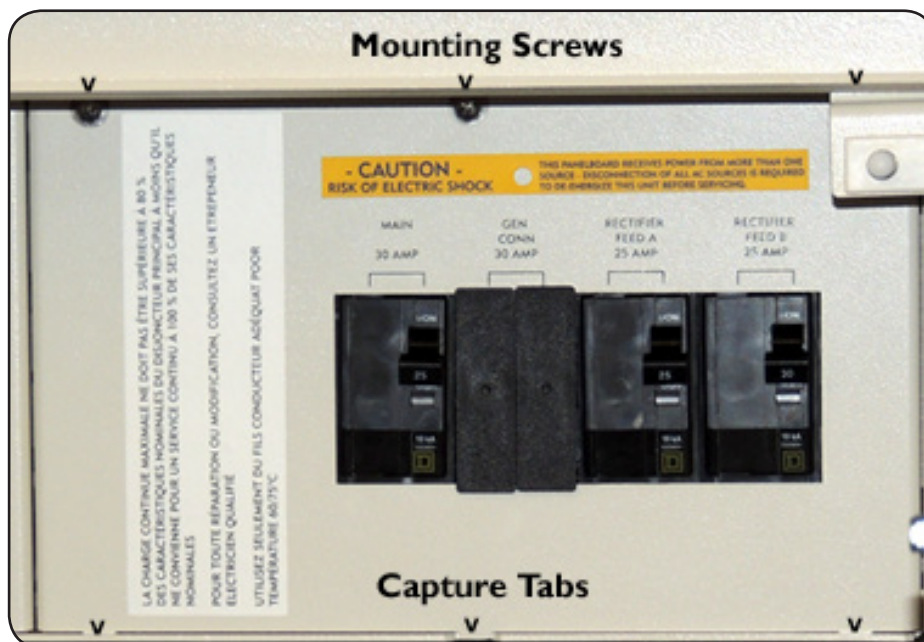

- Step 4:** Remove the four bolts securing the cabinet to the pallet. The bolts are located at the bottom corners of the cabinet, and can be accessed by removing the left and rear access panels as needed.

When the tasks above are complete, the cabinet is ready for installation.

FieldSmart® Fiber Active Cabinet (FAC) 900

Installation Manual



Preparing the EXM for Installation

Complete the following preparations before installing the Expansion Module (EXM).

To prepare the EXM for installation

- Step 1:** Open the EXM door.
- Step 2:** Remove the isolation mat and the bag containing the installation hardware from the EXM compartment. Set them aside for use during installation.
- Step 3:** Remove the four bolts, flat washers, and lock washers securing the EXM to the pallet. The bolts are located at the bottom corners of the EXM, and can be accessed by removing the left and rear access panels as needed.

When the tasks above are complete, the EXM is ready for installation.



FieldSmart® Fiber Active Cabinet (FAC) 900

Installation Manual

Installing the Cabinet or Riser on a Concrete Pad

Clearfield offers several models of optional cabinet risers. The riser ships detached from the cabinet, even when ordered as a factory option. Install the riser onto the concrete pad, and then mount the cabinet onto the riser.

The FAC 900 cabinet's compact design allows you to install it without the use of heavy lifting machinery. Clearfield recommends using two people to install the cabinet (to lift, move, and lower the cabinet onto the pad or riser).

If the required manpower is not available, or local practice requires the use of a lifting device, the cabinet is equipped with two lifting details on which to attach slings to lift and move the cabinet using a boom crane, derrick, or backhoe. Use wire rope slings and appropriately rated connecting links or lifting hooks. The lifting device and slings you use must be capable of lifting at least a 200 lb. working load. When using a lifting device to place the cabinet, follow these guidelines:

- Check the two lifting details on top of the cabinet to ensure that they are securely attached.
- Attach the lifting slings to the lifting device; attach the other sling ends to the cabinet lifting details with connecting links or hooks.
- Do not disconnect the slings from the cabinet until after it rests securely on the pad.



CAUTION! Installing the cabinet requires safe handling to ensure that no injury to personnel or damage to the cabinet occurs. Do not place any part of your body under the load during lifting. Follow local safety practices for lifting and moving heavy loads.



ALERT! Isolation mat usage is mandatory for concrete pad installations. Failure to use the supplied isolation mat can accelerate cabinet corrosion and may void the Clearfield cabinet warranty.

Before installing the cabinet, verify that the doors have been removed or are locked in the open position (wind brace engaged).

To install the cabinet or riser on a concrete pad

- Step 1:** Sweep the pad free of dirt and debris.
- Step 2:** Install the isolation mat onto the concrete pad.
- Step 3:** Using two people, lift the cabinet or riser directly above its mounting position on the pad.

Note: Refer to the instructions above for lifting a cabinet onto the pad with a lifting device.

FieldSmart® Fiber Active Cabinet (FAC) 900

Installation Manual



Step 4: Slowly lower the cabinet or riser onto the pad, keeping the mounting holes in the cabinet base aligned with the anchor studs (or holes) in the pad.

Note: *If properly aligned, the entry ducts should slide down over the conduits as the cabinet or riser lowers. If necessary, trim the conduit down to a height that enables it to pass into the entry duct.*

Step 5: Trim the AC sealing boot so that the open diameter is slightly smaller than the conduit to provide a water-tight seal.

Step 6: Pull the earth ground wire into the cabinet or riser through one of the cable entry ducts.

Step 7: Anchor the cabinet or riser to the pad as follows:

- Site-cast pads with anchor studs:
 - a. Get the four hex nuts, four flat washers, and four lock washers from the installation kit.
 - b. Install one flat washer, lock washer, and hex nut onto each of the four anchor studs.
 - c. Tighten the hex nuts to secure the cabinet or riser to the pad.
- Pre-cast pads with threaded inserts:
 - a. Get four anchor bolts, four flat washers, and four lock washers from the installation kit.
 - b. Install one flat washer, lock washer, and anchor bolt into each of the four threaded mounting inserts.
 - c. Tighten the bolts to secure the cabinet or riser to the pad.

Step 8: Verify that the doors open and close freely. If necessary, use shims to level the cabinet or riser.

Note: *If you removed the doors previously, re-install them to check door swing alignment. See [Installing a Cabinet Door](#) for instructions.*

Clearfield recommends applying silicone caulking to the bottom perimeter of the cabinet or riser once the installation is complete.

To install the cabinet on the riser

Step 1: Using two people, lift the cabinet onto the riser, keeping the (4) anchor holes in the cabinet base aligned with the counterpart holes in the riser.

Step 2: Attach the cabinet base to the riser using (4) anchor bolts, (8) flat washers, (4) lock washers, and (4) nuts (one set per each of the four anchor holes).

Step 3: Tighten all hardware to secure the cabinet to the riser.



FieldSmart® Fiber Active Cabinet (FAC) 900

Installation Manual

Installing an EXM (and Riser) on a Concrete Pad

Note: Install the base FAC 900 cabinet before installing an Expansion Module (EXM).

Clearfield offers several models of optional risers for use with the EXM when installing an FAC 900 cabinet with a riser. The riser height must match the height of the riser installed for the FAC 900. The riser ships detached from the EXM, even when ordered as a factory option.

The EXM's compact design allows you to install it without the use of heavy lifting machinery. Clearfield recommends using two people to install the EXM (to lift, move, and lower the EXM onto the pad).

If the required manpower is not available, or local practice requires the use of a lifting device, the EXM is equipped with two lifting details on which to attach slings to lift and move the EXM using a boom crane, derrick, or backhoe. Use wire rope slings and appropriately rated connecting links or lifting hooks. The lifting device and slings you use must be capable of lifting at least a 200 lb. working load. When using a lifting device to place the EXM, follow these guidelines:

- Check the two lifting details on top of the EXM to ensure that they are securely attached.
- Attach the lifting slings to the lifting device; attach the other sling ends to the EXM lifting details with connecting links or hooks.
- Do not disconnect the slings from the EXM until after it rests securely on the pad.



CAUTION! Installing the EXM requires safe handling to ensure that no injury to personnel or damage to the EXM occurs. Do not place any part of your body under the load during lifting. Follow local safety practices for lifting and moving heavy loads.



ALERT! Isolation mat usage is mandatory for concrete pad installations. Failure to use the supplied isolation mat can accelerate cabinet corrosion and may void the Clearfield EXM warranty.

Before installing the EXM, identify your *cabinet configuration* (in-line or L-configuration).

To install the EXM on a concrete pad

Step 1: Sweep the pad free of dirt and debris.

Step 2: Prepare for mounting the EXM on the FAC 900 cabinet:

- a. Depending on your cabinet configuration (in-line or L-configuration), remove either the rear or side access panel from the FAC 900. From outside the FAC 900 compartment, use a 5/32 hex security driver to remove the eight tamper resistant screws anchoring each panel to the compartment wall.
- b. Repeat step 2a to remove the side access panel on the EXM. Retain all access panel hardware.
- c. Remove or lock the EXM door in the open position (wind brace engaged).

FieldSmart® Fiber Active Cabinet (FAC) 900

Installation Manual



Step 3: Mark the locations to drill holes for the user-supplied 1/2 x 13 concrete inserts on the pad as follows:

- a. Using two people, lift the EXM directly above its mounting position on the pad, with the sealing gasket on the EXM rear or side wall oriented toward the FAC 900.

Note: Refer to the instructions above for lifting an EXM onto the pad.

- b. Slowly lower the EXM onto the pad, and position it against the FAC 900 wall, aligning the mounting holes on the EXM side with the counterpart threaded nuts on the FAC 900.

Note: If properly aligned, the entry ducts should slide down over the conduits as the EXM lowers. If necessary, trim the conduit down to a height that enables it to pass into the entry duct.

- c. From inside the EXM, locate the (4) mounting holes in the base of the module, and mark each one on the pad.
- d. Remove the EXM from the pad.

Step 4: Install each concrete insert into a marked location on the pad as follows:

- a. Use a hammer drill to drill the appropriate diameter hole for a 1/2-13 inch hole concrete insert.
- b. Clear all dirt and debris from the hole using a wire brush or vacuum.
- c. Install an insert into the hole, making sure that it is level with the pad.

Step 5: Install the isolation mat onto the concrete pad.

Step 6: Using two people, lift the EXM directly above its mounting position on the pad, with the EXM sealing gasket oriented toward the FAC 900 rear or side wall, depending on your configuration.

Step 7: Slowly lower the EXM onto the pad, and position it against the FAC 900 wall, aligning the mounting holes on the base of the EXM with the counterpart concrete inserts in the pad.

Step 8: Pull the earth ground wire into the EXM through one of the cable entry ducts.

Step 9: Attach the EXM to the pad as follows:

- a. Get four bolts, four flat washers, and four lock washers from the installation kit.
- b. Install one bolt, flat washer, and lock washer into each of the concrete inserts, but do not tighten.

Note: The hardware must be loose enough to allow the EXM to shift slightly when secured to the FAC 900.



FieldSmart® Fiber Active Cabinet (FAC) 900

Installation Manual

Step 10: Attach the EXM to the FAC 900 cabinet as follows:

- a. Get the six shoulder screws, six flat washers and six lock washers from the installation kit.
- b. From inside the EXM, install one screw, lock washer and flat washer in the mounting holes on the EXM wall, and into corresponding threaded nut on the FAC 900 compartment wall.
- c. Tighten the screws to secure the EXM to the FAC 900, ensuring that the EXM gasket is compressed around the entire perimeter of the gasket for a water tight seal.

Step 11: Tighten the bolts in the base of the EXM completely to secure the module to the pad.

Step 12: Route the EXM subground wire through the access panel and to the cabinet's main ground bar. Attach the ground wire lugs to the EXM subground position on the main ground bar. To install the EXM's connection to an earth ground circuit, refer to *Installing the Cabinet and EXM Ground Connections*.

Step 13: Verify that the door opens and closes freely. If necessary, use shims to level the EXM.

Note: If you removed the door previously, re-install it to check door swing alignment. See *Installing a Cabinet Door* for instructions.

Clearfield recommends applying silicone caulking to the bottom perimeter of the EXM once the installation is complete.

To install a riser (6- or 12-inch) with EXM on a concrete pad

Step 1: Sweep the pad free of dirt and debris.

Step 2: Attach the EXM to the riser as follows:

- a. Using appropriate lifting straps secured to the lift details, place the EXM onto the riser.
- b. Get four bolts, four flat washers, and four lock washers from the installation kit.
- c. Install one bolt, flat washer, and lock washer into each of the mounting holes in the base on the EXM cabinet.
- d. Tighten the bolts to secure the EXM to the riser.

Step 3: Mark the locations to drill holes for the user-supplied 1/2-13 inch concrete inserts on the pad as follows:

- a. Place the riser and EXM on the pad, and position against the side or rear of the FAC 900 (depending on your configuration), aligning the mounting holes on the side of the EXM with the counterpart threaded nuts on the FAC 900. Allow an offset gap of .35" between the FAC 900 riser and the EXM riser.

FieldSmart® Fiber Active Cabinet (FAC) 900

Installation Manual



Note: If properly aligned, the entry ducts should slide down over the conduits as the riser lowers. If necessary, trim the conduit down to a height that enables it to pass into the entry duct.

- b. Apply silicone caulking to the bottom perimeter of the EXM riser, and then allow the silicone to dry.
- c. Remove the EXM from the riser, taking care to keep the riser in place on the pad.
- d. Locate the (4) mounting holes in the base of the riser, and mark each one on the pad.
- e. Remove the silicone mounted riser from the pad by pulling up one side to break the silicone loose.

Step 4: Install each concrete insert into a marked location on the pad as follows:

- a. Use a hammer drill to drill the appropriate diameter hole for a 1/2-13 inch concrete insert.
- b. Clear all dirt and debris from the hole using a wire brush or vacuum.
- c. Install an insert into the hole, making sure that it is level with the pad.

Step 5: Install the isolation mat onto the concrete pad.

Step 6: Place the riser on the pad, and position it against the FAC 900, aligning the mounting holes on the base of the riser with the counterpart concrete inserts in the pad. Verify that you have an offset gap of .35" between the FAC 900 riser and the EXM riser.

Step 7: (Optional) Pull the earth ground wire into the EXM riser through one of the cable entry ducts.

Step 8: Attach the riser to the pad as follows:

- a. Get four bolts, four flat washers, and four lock washers from the installation kit.
- b. Install one bolt, flat washer, and lock washer into each of the concrete inserts.
- c. Tighten the bolts to secure the riser to the pad.

Step 9: Fill the riser's outside plant cable entry location with river stone rock up to the bottom of where the FAC 900 mounts.



FieldSmart® Fiber Active Cabinet (FAC) 900

Installation Manual

Step 10: Prepare for mounting the EXM on the FAC 900 cabinet:

- a. Depending on your cabinet configuration (in-line or L-configuration), remove either the rear or side access panel from the FAC 900. From outside the FAC 900 compartment, use a 5/32 hex security driver to remove the eight tamper resistant screws anchoring each panel to the compartment wall.
- b. Repeat step 2a to remove the access panel on the EXM. Retain all access panel hardware.
- c. Remove or lock the EXM door in the open position (wind brace engaged).

Step 11: Using appropriate lifting straps secured to the lift details, place the EXM onto the riser, aligning the mounting holes on the side of the EXM with the counterpart threaded nuts on the FAC 900.

Step 12: Attach the EXM to the FAC 900 cabinet as follows:

- a. Get the six shoulder screws, six flat washers and six lock washers from the installation kit.
- b. From inside the EXM, install one screw, lock washer and flat washer in the mounting holes on the EXM wall, and into corresponding threaded nut on the FAC 900 compartment wall.
- c. Tighten the screws to secure the EXM to the FAC 900.

Step 13: Attach the EXM to the riser as follows:

- a. Get four bolts, four flat washers, and four lock washers from the installation kit.
- b. Install one bolt, flat washer, and lock washer into each of the mounting holes in the base on the EXM cabinet.
- c. Tighten the bolts to secure the EXM to the riser.

Step 14: Route the EXM subground wire through the access panel and to the cabinet's main ground bar. Attach the ground wire lugs to the EXM subground position on the main ground bar. To install the EXM's connection to an earth ground circuit, refer to *Installing the Cabinet and EXM Ground Connections*.

Clearfield recommends applying silicone caulking to the bottom perimeter of the EXM riser once the installation is complete.

FieldSmart® Fiber Active Cabinet (FAC) 900

Installation Manual



Installing the Enclosure(s) on a Wall or H-Frame

The FAC 900 cabinet and EXM are equipped with four lifting details on which to attach slings to lift and move the enclosure using a boom crane, derrick, or backhoe. Use wire rope slings and appropriately rated connecting links or lifting hooks. The lifting device and slings you use must be capable of lifting at least a 200 lb. working load.

Clearfield recommends using at least three people to install the cabinet and EXM: one to operate the crane or derrick, one to guide the enclosure(s) laterally as it lowers, and one to spot-check alignment of the mounting studs/holes and conduits/entry box as the enclosure lowers.



CAUTION! Installing the cabinet or EXM requires safe handling to ensure that no injury to personnel or damage to the cabinet occurs. Do not place any part of your body under the load during lifting. Follow local safety practices for lifting and moving heavy loads.

Before installing the cabinet and EXM, verify that the door(s) has been removed or locked in the open position (wind brace engaged).

To install the enclosure(s) on a wall mount or H-frame

- Step 1:** Check the two lifting details on top of the FAC 900 to ensure that they are securely attached.
- Step 2:** Attach the lifting slings to the lifting device; attach the other sling ends to the enclosure lifting details with connecting links or hooks.
- Step 3:** Lift the FAC 900 at least 12 inches higher than—and position it directly above—the (2) mounting brackets intended for the cabinet.
- Step 4:** Slowly lower the FAC 900 onto the mounting brackets, keeping the holes in the cabinet base aligned with the mounting holes in the mounting brackets.

Note: *If properly aligned, the entry duct in the cabinet should slide down over the conduits protruding up from the conduit assembly as the cabinet lowers. If necessary, reach down through the entry duct to grasp and align the conduit to guide it through the entry duct. Do not reach under the cabinet.*

- Step 5:** Pull the earth ground wire into the compartment through the cable entry box.
- Step 6:** Before removing the lifting device, from inside the FAC 900, loosely install (2) 1/2"-13 x 1.25" hex screws through holes at each end of the cabinet base and the counterpart holes in the mounting brackets to prevent the cabinet from slipping off the brackets.
- Step 7:** Remove the lifting device from the FAC 900.



FieldSmart® Fiber Active Cabinet (FAC) 900

Installation Manual

Step 8: To install the EXM, do the following:

- a. Repeat steps 1–3 above.
- b. Slowly lower the EXM onto the mounting brackets, and position it against the FAC 900 wall, aligning the mounting holes on the base on the EXM with the mounting holes in the mounting brackets.

Note: *If properly aligned, the entry duct in the EXM should slide down over the conduits protruding up from the conduit assembly as the EXM lowers. If necessary, reach down through the entry duct to grasp and align the conduit to guide it through the entry duct. Do not reach under the EXM.*

- c. Pull the earth ground wire into the compartment through the cable entry box.
- d. Before removing the lifting device, from inside the EXM, loosely install (2) 1/2"-13 x 1.25" hex screws through holes at each end of the EXM base and the counterpart holes in the mounting brackets to prevent the enclosure from slipping off the brackets.
- e. Remove the lifting device from the EXM.

Step 9: Attach the EXM to the FAC 900 cabinet as follows:

- a. Get the six shoulder screws, six flat washers and six lock washers (provided with the EXM installation kit).
- b. From inside the EXM, install one screw, lock washer and flat washer in the mounting holes on the EXM wall, and into corresponding threaded nut on the FAC 900 compartment wall.
- c. Tighten the screws to secure the EXM to the FAC 900, ensuring that the EXM gasket is compressed around the entire perimeter of the gasket for a water tight seal.

Step 10: Remove the right-side lifting detail from the FAC 900 and EXM, as required:

- a. Remove the (3) bolts securing the lifting detail to the enclosure.
- b. Remove the lifting detail, and set aside hardware.

Step 11: Install the stabilizer brackets. Refer to Installing the Stabilizer Bracket(s) for instructions.

FieldSmart® Fiber Active Cabinet (FAC) 900

Installation Manual



Step 12: Secure the FAC 900 to the mounting brackets as follows:

- a. Remove the 1/2"-13 x 1.25" hex screws loosely installed in Step 6.
- b. Slide the enclosure flush against the horizontal beams.
- c. Get (4) 1/2"-13 x 1.25" hex screws, (8) 1/2" flat washers, (8) 1/2" split lock washers, and (4) 1/2"-13 hex nuts.
- d. Install one hex screw, one flat washer and one split lock washer into each of the four mounting holes.
- e. Tighten the screws to secure the enclosure to the mounting brackets.

Step 13: To secure the EXM to the mounting brackets, remove the 1/2"-13 x 1.25" hex screws loosely installed in Step 8d, and then repeat steps 12b–12e.

Step 14: If you removed the door(s) previously, re-install and check the door swing alignment.

Step 15: Apply silicone caulking to seal the conduit feed throughs to the base of the enclosure(s).

Step 16: Once the silicone dries, use the supplied expansion foam to further seal the feed through tray inside the enclosure(s).



FieldSmart® Fiber Active Cabinet (FAC) 900

Installation Manual

Removing the Lifting Details

After the cabinet or EXM is installed, remove the two lifting details from the enclosure.

To remove the lifting details

Step 1: Locate the two lifting details:

- **FAC 900:** Attached to the upper left corners of the left and right sides of the cabinet.
- **EXM:** Attached to the upper left corner of the left side and the upper right corner of the rear compartment wall.

Step 2: Remove the three bolts securing the first lifting detail to the enclosure.

Step 3: Remove and discard the lifting detail.

Step 4: Insert the three removed bolts back into the vacant bolt holes on the enclosure.

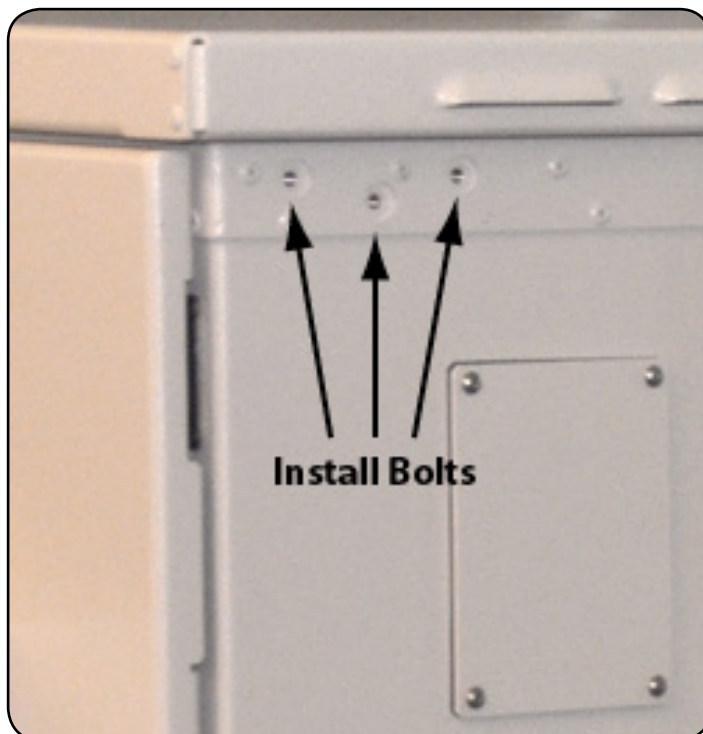

Step 5: Repeat Steps 2–4 to remove the other lifting detail.

Chapter 5: Installing Local AC Power

This chapter describes how to install power to the cabinet.

This process includes installing the cabinet earth ground connection and installing and wiring local AC power.

Install power according to your cabinet configuration type.

Topics Covered

This chapter covers the following topics:

- Installing the cabinet ground connection
- Installing local AC power



FieldSmart® Fiber Active Cabinet (FAC) 900

Installation Manual

Installing the Cabinet and EXM Ground Connections

You must install the cabinet's connection to the earth ground circuit before you connect commercial power to the cabinet. You may also install the Expansion Module's (EXM) connection to an earth ground circuit, however this is optional.

Guidelines

Clearfield recommends adhering to PANI grounding methods to reduce ground current interaction:

- The PANI system divides the ground bar into sections, with one type of conductor in each section: **Producers**, surge **Absorbers**, **Non-isolated** and **Isolated** (PANI).
- The middle position on the ground bar bisects separate ground connections for surge producers from surge absorbers/active electronics.
- The earth ground connection on the cabinet ground bar serves as the primary surge absorber to isolate the equipment grounds from the surge-producing grounds.
- The EXM subground bar serves as the primary surge absorber to isolate the equipment grounds from the surge-producing external grounds in the EXM, when installed. For the EXM earth ground connection, choose one of the following methods (but not both):
 - **Best practice:** Connect the "Earth Ground" lugs on the EXM subground bar to a ground rod.
 - **Alternate:** Connect from the "Earth Ground" lugs on the EXM subground bar to the "FAC 900/EXM Subground" lugs on the FAC 900 main ground bar.

FieldSmart® Fiber Active Cabinet (FAC) 900

Installation Manual

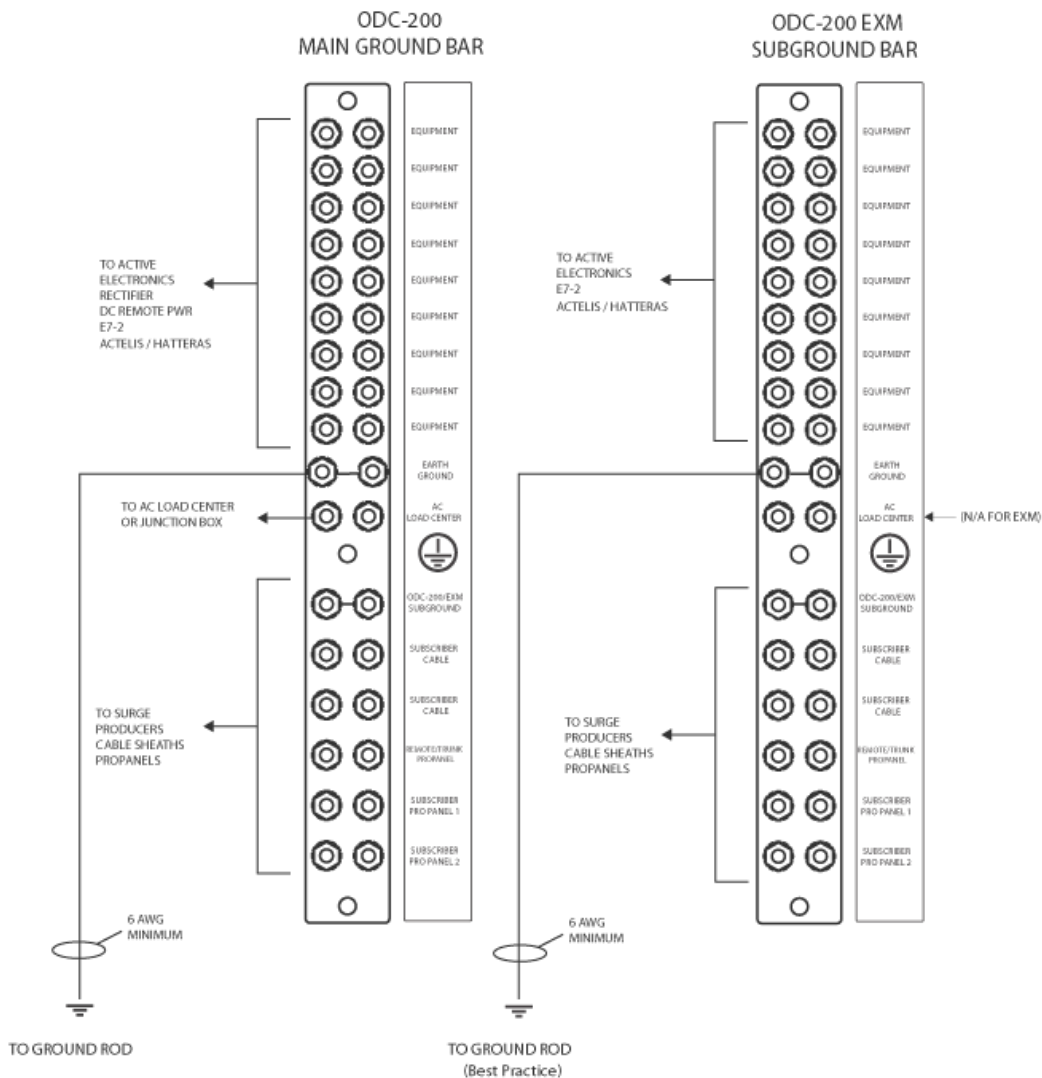

To install the cabinet or EXM ground connection

- Step 1:** Open the side cabinet or EXM door.
- Step 2:** Route the earth ground wire to the main ground bar (or subground bar for the EXM) and cut the wire to length.
- Step 3:** Using a ratcheting crimp tool with embossing dies, attach a two-hole compression lug (#2–6 AWG, 3/4-inch hole spacing) to the earth ground wire. Ensure that the correct lug is used to match the earth ground wire.
- Step 4:** At the middle of the ground bar, locate a ground position with 3/4-inch stud spacing. Remove the nuts from the identified terminal studs.
- Step 5:** Attach the earth ground wire's two-hole lug onto the 3/4-inch ground terminal studs (labeled *Earth Ground*) per PANI guidelines.
- Step 6:** Re-connect the nuts to the ground terminal studs and tighten to 26 inch-lbs. of torque.



FieldSmart® Fiber Active Cabinet (FAC) 900

Installation Manual

Installing AC Power (208-240 VAC)

This section describes how to install local AC power (208–240 VAC standard) to the cabinet for an AC load center or AC junction box.

AC Load Center: Installing Power

Cabinets factory equipped with an AC load center support 208-240 VAC service.



DANGER! High voltage may be present. Do not apply AC power to the cabinet until the installation process is complete.



WARNING! Electrical hazard. Only a qualified electrician should perform this procedure.

Before proceeding, verify that AC service to the cabinet site is OFF at the local power transfer switch.

To install AC power (208-240 VAC)

Note: Refer to the AC Load Center wiring diagram (on Clearfield's website, seeClearfield.com) for guidance. An AC wiring label is attached behind the load center front panel for reference.

- Step 1:** Open the cabinet's front door.
- Step 2:** At the cabinet AC load center, switch all breakers to the OFF position.
- Step 3:** Remove the right AC cover panel as follows:

- a. Remove the (3) mounting screws securing the cover panel to the fixture.
- b. Push up on the (2) lifting tabs, angle the panel away from the fixture, and lift the panel from the (3) capture tabs on the bottom of the fixture.

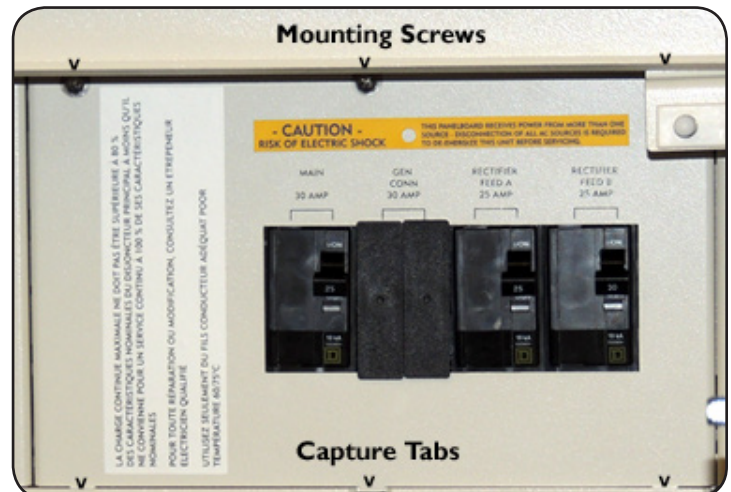

FieldSmart® Fiber Active Cabinet (FAC) 900

Installation Manual



- Step 4:** From inside the AC load center, push the plug out from the AC input hole and install the supplied cord grip and locknut.
- Step 5:** Pull the AC cable into the cabinet through the duct entry in the base of the cabinet.
- Step 6:** Route the AC cable to the rear of the AC load center and feed it through the cord grip in the AC input hole.
- Step 7:** Connect the AC wiring as follows:
- Connect the green (ground) lead to the ground bus bar (strip and tin the wire as needed).
 - Connect the white (neutral) lead to the neutral bar.
 - Connect the black L1 lead to the left side of the Main breaker.
 - Connect the red L2 lead to the right side of the Main breaker.
- Step 8:** Dress and secure the AC cable, providing adequate strain relief.
- Step 9:** Replace the right cover panel on the AC load center.

AC Junction Box: Installing Power

Cabinets factory equipped with the AC junction box option support 120/240 VAC service in conjunction with use of 40 Amp rectifier modules.

Note: The AC junction box does not support 110/120 VAC input power.



DANGER! High voltage may be present. Do not apply AC power to the cabinet until the installation process is complete.



WARNING! Electrical hazard. Only a qualified electrician should perform this procedure.

Before proceeding, verify that AC service to the cabinet site is OFF at the local power transfer switch.



FieldSmart® Fiber Active Cabinet (FAC) 900

Installation Manual

To install AC power (120/240 VAC)

Note: Refer to the AC junction box wiring diagram (on Clearfield's website, seeclearfield.com) for guidance. An AC wiring label is attached behind the junction box front panel for reference

- Step 1:** Open the front cabinet door.
- Step 2:** At the customer supplied circuit breaker box, switch all breakers off.
- Step 3:** Remove the right AC cover panel as follows:
- Remove the (3) mounting screws securing the cover panel to the fixture.
 - Push up on the (2) lifting tabs, angle the panel away from the fixture, and lift the panel from the (3) capture tabs on the bottom of the fixture.
- Step 4:** From inside the AC junction box, push the plug out from the AC input hole and then install the supplied cord grip and locknut.
- Step 5:** Install a user-supplied AC conduit between the outside entry duct in the cabinet floor and the junction box entry location. Install the conduit per local practice. Make sure the conduit is rated for AC cabling.
- Step 6:** Pull the customer supplied AC wires into the cabinet through the duct entry in the base of the cabinet.
- Step 7:** Route the AC wires to the rear of the AC junction box and feed it through the cord grip in the AC input hole.
- Step 8:** Connect the AC wiring as follows:
- Connect the ground (green) leads to the ground bus bar.
 - Connect the L1 (black) and L2 (white) leads to the terminal block positions: Rectifier Feed A, Rectifier Feed B, GFCI Outlet, and (optional) Battery Heater.
- Step 9:** Tighten the cord grip around the AC wires at the rear of the junction box.
- Step 10:** Re-install the right cover panel on the AC junction box.



Chapter 6: Installing and Splicing Outside Plant Cables

This chapter describes how to install and splice outside plant cables into the cabinet or EXM, including fiber plant (fiber-optic cables for transport and/or subscriber drops) and metallic plant (copper twisted pairs for subscriber drops and/or transport).

Topics Covered

This chapter covers the following topics:

- Installing fiber cable
- Installing metallic cables
- Sealing cable entry locations



FieldSmart[®] Fiber Active Cabinet (FAC) 900

Installation Manual

Bonding Cable Sheaths

The subscriber and optical cable sheaths must be bonded as follows:

- Bond the metallic sheaths of all subscriber and optical cables to a grounding rod or system at their first appearance at the cabinet/enclosure site (at the copper pedestal or splice case, and so forth). If this point is close enough to bond to the cabinet/enclosure grounding system, bond to the same point on the main site ground bar (SPGP or equivalent) that the cross-connect bonds to.
- Bond the metallic sheaths of all subscriber and optical cables to a grounding rod or system at regular intervals along the entire run external to the cabinet/enclosure site, per RUS guidelines.
- Clearfield recommends that you bond optical fiber cable sheaths at the first entrance to the cabinet/enclosure site only (the splice case, or similar), and then isolate the sheaths in the short run between splice point and the Clearfield equipment cabinet/enclosure ground. The short run can then be bonded on either side (the Clearfield ground bar side or splice point side, but not both) per local practice.
- Clearfield recommends that you bond the subscriber cable sheaths at the first entrance to the cabinet/enclosure site (the copper pedestal, and the ground bar of any cross-connect cabinet), and then isolate the sheaths in the short run between cross-connect cabinet and the Clearfield equipment cabinet/enclosure ground. The short run can then be bonded on either side (Clearfield ground bar side or cross-connect side, but not both) per local practice.

FieldSmart® Fiber Active Cabinet (FAC) 900

Installation Manual



Installing Fiber Cable

This section describes how to install fiber optic cables into the cabinet or EXM, including how to route and groom the outside plant cable and splice fibers to the distribution systems.

Fiber management guidelines

When installing, splicing, and routing fibers in the cabinet or EXM, follow these guidelines:

- Avoid tight bend radii for fibers and provide adequate strain relief.
- Dress and secure fiber jumpers using velcro straps or other soft-tie method designed for fiber. Avoid using plastic cable ties, which can damage a fiber.
- Label jumpers to simplify identification at splice and distribution locations.

Installing Outside Plant Fiber Cable

Install outside plant (OSP) fiber cable into the cabinet and/or EXM and prepare it for splicing. The following steps are general guidelines only. Follow local practice wherever applicable.

To install outside plant fiber cable

- Step 1:** Open the side cabinet or front EXM door.
- Step 2:** Route the OSP fiber cable from the feeder location through the conduit and up into the compartment.
- Step 3:** Pull the fiber cable up into the compartment through the entry duct. Pull enough cable length to extend to the splicing location.
- Step 4:** Using ropes or cable ties, temporarily hang and secure the OSP cables inside the compartment.
- Step 5:** If splicing shall be performed at a later time, make sure the cable arrangement allows the door to close. Take care to not violate the cable bend radius requirements.

The following steps are general guidelines only. Follow local practice where applicable.

To prepare outside plant cables for splicing

- Step 1:** If necessary, untie or cut the bindings temporarily securing the OSP cable inside the cabinet or EXM.
- Step 2:** Strip off the cable's outer sheath to expose the core tubing. Take care not to damage the fibers inside the core tubing.



FieldSmart® Fiber Active Cabinet (FAC) 900

Installation Manual

Step 3: Ground the OSP cable sheath to the cabinet's main ground bar or the EXM's subground bar as follows:

- a. Twist the OSP cable's metal strength members together into a single strand.
- b. Install a lug connector on the twisted end of the strength members.

Note: Clearfield recommends using a two-hole lug connector, unless local practice indicates otherwise.

- c. Install a #6 AWG bond strap onto the lug connector together with the twisted strength members and tighten the lug connector.
- d. Terminate the other end of the bond strap to the ground bar in an open position below the AC load center or junction box lug. Refer to *Installing the Cabinet Ground Connection* for more information.

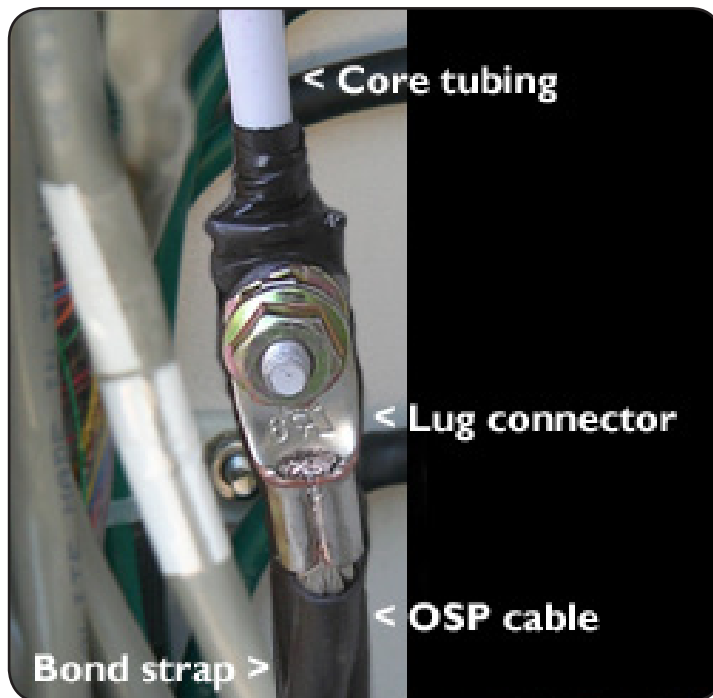

Step 4: Route fiber to the splice location:

- a. Insert the core tubing into the fiber routing duct and feed it through the duct into the cabinet or EXM.
- b. Route the core tubing to the splice location to determine the required length.
- c. Strip off the core tubing to an appropriate length. Take care not to sever or nick the bare fibers.

Step 5: If splicing shall be performed at a later time, neatly coil the bare fibers inside the splice tray. Secure the core tubing in place with cable ties.

FieldSmart® Fiber Active Cabinet (FAC) 900

Installation Manual



Splicing Fibers

Note: If the fiber splices will not reside inside the cabinet or EXM, skip this section. Splice fibers per local practice.

Common methods for splicing fibers to distribution systems or optical equipment include:

- **Pigtail splicing:** Splice OSP fibers to connectorized pigtails that plug into a distribution panel, where they mate with fiber jumpers that connect to the equipment. This method provides flexibility, where the distribution panel serves as a patch panel for equipment with different connector types.
- **Jumper splicing:** Splice OSP fibers directly to jumpers that connect to the optical equipment, bypassing any intermediate patch panels.

Both splicing methods typically use a fiber splice tray to hold the individual splices. Clearfield offers splice tray options with fusion, heat shrink, and mechanical splicing options. Each splice tray can hold up to 12 fiber splices.



DANGER! CLASS 1 LASER PRODUCT. INVISIBLE LASER RADIATION MAY BE PRESENT. Fiber optic radiation can cause severe eye damage or blindness. Do not look into the open end of an optical fiber.



CAUTION! Only a qualified technician should perform this procedure.

To splice fibers

- Step 1:** Open the side cabinet or front EXM door.
- Step 2:** If necessary, untie or cut any bindings temporarily securing the core fiber tubing near the splice tray.
- Step 3:** Remove the fiber splice tray containing bare fibers from the tray holder.
- Step 4:** Remove enough fiber from the tray to perform splicing. Thoroughly clean all bare fibers, as needed.
- Step 5:** Splice the fibers to fiber pigtails or jumpers per local practice.
- Step 6:** Neatly arrange the finished splices and slack fiber in the splice tray.
- Step 7:** Insert the splice tray into the tray holder and secure the tray in place using a supplied Velcro strap.
- Step 8:** Dress any slack fiber from the pigtails or jumpers around the dressing assembly. Secure the fibers in place with a Velcro strap.



FieldSmart® Fiber Active Cabinet (FAC) 900

Installation Manual

Routing and Terminating Fibers

Route fibers from the splice location to the termination location. The termination equipment and location may vary by configuration:

- With the pigtail splicing method, you typically route pigtails from the splice tray to a distribution panel and plug the pigtail connectors into the panel. You can then use jumpers to connect to the optical equipment from the distribution panel.
- With the jumper splicing method, you typically route jumpers from the splice tray directly to the optical equipment. No intermediate patch panel is typically used.

Route and terminate fibers per your application requirements and local practice. Clearfield offers optional fiber distribution systems, including 12-, 24-, 48- or 96-position fiber splice or distribution panels. Adapters are available with SC or LC connector options.



DANGER! CLASS 1 LASER PRODUCT. INVISIBLE LASER RADIATION MAY BE PRESENT. Fiber optic radiation can cause severe eye damage or blindness. Do not look into the open end of an optical fiber.

To route and terminate fibers to equipment

Step 1: At the splice tray, locate the fiber pigtails or jumpers to route and terminate.

Step 2: Route the fibers to the termination point and temporarily drape on the equipment.

Step 3: Terminate the fibers using one of the following methods:

- **Direct connection:** Connect jumpers to the optical equipment.
- **Fiber distribution bulkhead:** Connect pigtails to the adapter plugs on the back side of the bulkhead.
- **Fiber termination cassette:**
 - a. Open the cassette and connect pigtails to the adapter plugs inside the cassette.
 - b. Coil the slack fiber inside, and then close the cassette.
 - c. Slide the cassette into any available position in the cassette holder (hook side down), and fold the cassette holder back flush against the bracket.

Step 4: If necessary, neatly coil any excess slack fiber into an arrangement that won't interfere with or become snagged on the equipment.

Step 5: Dress and secure fibers in place with Velcro straps.

FieldSmart® Fiber Active Cabinet (FAC) 900

Installation Manual



Connecting Fibers to the Equipment

Before you can connect fibers to the equipment, you must first install one or more pluggable transceiver modules into the optical Ethernet port sockets. If the laser at the far end is enabled, you can use an optical power meter to test the signal strength on the fibers before connecting to the equipment. Defer to local practice wherever applicable.



DANGER! CLASS 1 LASER PRODUCT. INVISIBLE LASER RADIATION MAY BE PRESENT. Optical radiation can cause severe eye damage or blindness. Never assume laser power is off. Do not look into the open end of an optical fiber, vacant SFP socket, or an installed transceiver.



Installing Metallic Cables

This section describes how to install metallic signal cables into the cabinet, including how to route and groom the outside plant cables and splice to the equipment cables.

Removing the Battery Enclosure

For additional space in the cabinet or EXM compartment when installing or splicing outside plant metallic cables, remove the battery enclosure as described below.

To remove the battery enclosure

- Step 1:** Open the side cabinet or front EXM door.
- Step 2:** Open the latch on each side of the terminal cover and remove the cover.
- Step 3:** Remove the seismic retaining bracket from the battery enclosure as follows:
 - a. Remove the temperature probe cable from the right upper hole in the retaining bracket.
 - b. Remove the (2) hex head screws and washers from each side of the retaining bracket.
 - c. Rotate the retaining bracket forward, and lift the bracket from the groove at the base of the battery enclosure.
- Step 4:** Remove the (8) mounting screws from each side of the enclosure, and lift the enclosure from the base of the cabinet or EXM.

FieldSmart® Fiber Active Cabinet (FAC) 900

Installation Manual



Installing Outside Plant Metallic Cables

Install outside plant (OSP) metallic cables into the cabinet (or EXM) and prepare the cables for splicing. The following steps are general guidelines only. Follow local practice where applicable.

Note: For additional space in the cabinet or EXM when installing OSP metallic cables, remove the Battery Enclosure (if present).

To install outside plant metallic cables

- Step 1:** Open the side cabinet or front EXM door.
- Step 2:** To keep the cabinet or EXM compartment clear of environmental gel, drape plastic sheeting over the door, protection panels, and the bottom of the splice area.
- Step 3:** Route the OSP metallic cables from the feeder location through the conduit and up into the compartment.



- Step 4:** Pull approximately six feet of each cable up into the compartment through the entry duct.
- Step 5:** Using ropes or cable ties, temporarily hang and secure the OSP cables inside the compartment.
- Step 6:** If splicing shall be performed at a later time, do the following:
- Remove the plastic sheeting.
 - Make sure the cable arrangement allows the door to close. Take care to not violate the cable bend radius requirements.



FieldSmart® Fiber Active Cabinet (FAC) 900

Installation Manual

The following steps are general guidelines only. Follow local practice where applicable.

To prepare outside plant cables for splicing

- Step 1:** To keep the cabinet or EXM compartment clear of environmental gel, drape plastic sheeting over the door, protection panels, and the bottom of the splice area, if you have not already done so.
- Step 2:** If necessary, untie or cut the bindings temporarily securing the OSP cables inside the compartment.
- Step 3:** Strip off the cable's outer sheath and internal metal shielding down to 12 inches above where the cable enters the compartment. Take care to expose, but not penetrate, the core wrap surrounding the bundled copper pairs.

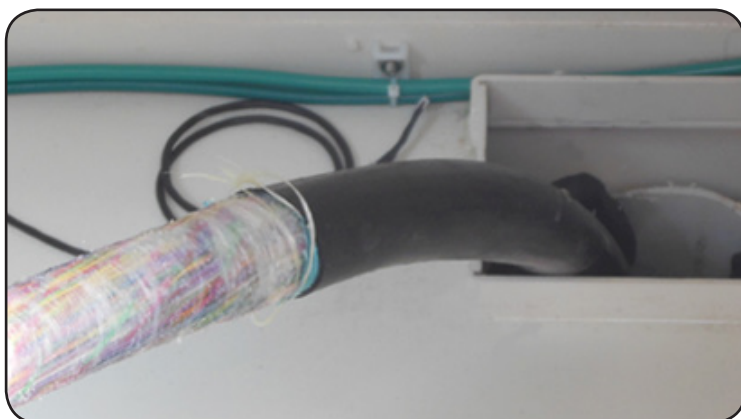

- Step 4:** Ground the OSP cable sheath to the cabinet's main ground bar or EXM's subground bar as follows:
- Install a B-bond clamp onto the cut end of the OSP cable's outer sheath. Wrap the connection with electrical tape.
 - Attach a #6 AWG bond strap to the B-bond clamp.
 - Terminate the other end of the bond strap to the main ground bar in an open position below the AC load center or junction box lug. Refer to *Installing the Cabinet Ground Connection* for more information.
- Step 5:** Secure the OSP cable to the rack or tie bars with cable ties.
- Step 6:** Remove the core wrap from around the bundled copper pairs, and then install binder group identification labels on each 25-pair group.
- Step 7:** Repeat Steps 1–5 for each OSP metallic cable.
- Step 8:** Remove the plastic sheeting from the cabinet.
- Step 9:** If splicing shall be performed at a later time, make sure cable arrangement allows the door to close. Take care to not violate the cable bend radius requirements.

FieldSmart® Fiber Active Cabinet (FAC) 900

Installation Manual



Splicing Metallic Cables

Mate the outside plant (OSP) cables to the equipment interface cables using MS2 or 710 connectors. Interface cables on the OSP side ('Subscriber' side) of the protection blocks are factory terminated with MS2 or 710 connectors. You must install counterpart MS2 or 710 connectors on each 25-pair group of OSP cables before mating.

Note: For additional space in the cabinet or EXM compartment when splicing OSP metallic cables, remove the Battery Enclosure (if present).

To splice the metallic cables

Note: Clearfield equipment uses a 'dead pair' scheme, where the 25th pair in each 25-pair cable group is unterminated and not used (dead). Refer to the pair assignment list shipped with the cabinet.

- Step 1:** Open the side cabinet or front EXM door.
- Step 2:** Turn the (2) knobs on the left side of the protection mounting frame counter-clockwise, and swing the frame forward.
- Step 3:** Segregate the bundled pairs from the OSP cable into 25-pair groups.
- Step 4:** Terminate MS2 or 710 connectors onto the ends of each 25-pair group per local practice.

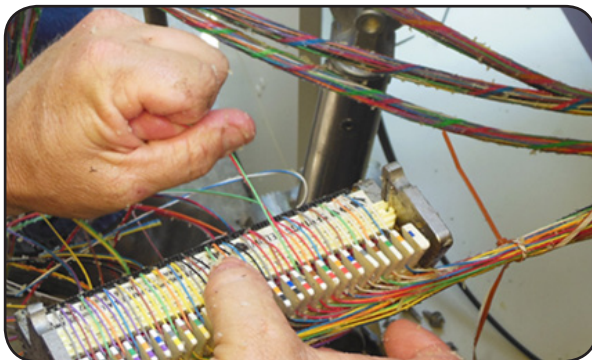

- Step 5:** Remove all cable ties securing the cabinet interface cables to tie bars and remove the protective covers from the connectors.
- Step 6:** For each 25-pair group, mate the OSP and equipment interface cable connectors together using the appropriate mating clamps.
- Step 7:** Repeat Steps 3 through 6 for each remaining OSP cable.
- Step 8:** Dress and secure the spliced cables to the tie bars with cable ties.
- Step 9:** While holding the swing frame closed against the rack, turn the (2) knobs clockwise to engage the latch, securing it in the closed position.



FieldSmart® Fiber Active Cabinet (FAC) 900

Installation Manual

Reinstall the Battery Enclosure

If you removed the battery enclosure to provide additional space in the cabinet or EXM when installing or splicing outside plant metallic cables, reinstall the battery enclosure as described below.

To reinstall the battery enclosure

- Step 1:** Place the battery enclosure in base of the FAC 900 or EXM, aligning the mounting bracket holes against the counterpart holes on the equipment rack.
- Step 2:** Install the eight mounting screws (4 per side) to secure the enclosure to the rack. Tighten the screws to 45 in. lbs. of torque.
- Step 3:** Ensure that the front bottom edge of the enclosure is up against the inside lip of the door jam. If not, loosen the screws that mount the rails to the top and bottom of the FAC 900 or EXM, pull the battery enclosure forward, and then re-tighten the screws.
- Step 4:** Replace the retaining bracket and terminal cover.
- Step 5:** Close the door and check to be sure that the battery housing properly seals against the door gasket. For the FAC 900, this can be viewed through the front equipment compartment; for the EXM, this can be viewed through the rear access panel using a flashlight.

Installing 5-Pin Protection Modules

To complete the circuit connections between the metallic outside plant cables and equipment, you must install 5-pin protection modules into the 50-pair protection blocks. The 5-pin protection modules serve as fuses to protect the equipment from electrical surges on the lines.

Each 5-pin position on the block protects one wire pair (one 2-wire circuit). Install a 5-pin protection module into each block position (circuit) that will be equipped for service. Refer to the cabinet pair assignment list for more information.

Note: Clearfield equipment uses a 'dead pair' scheme, where the 25th pair in each 25-pair cable group is unterminated (dead). Therefore, on each protection block, positions 25 and 50 are not wired. Line identification labels cover the dead pair positions.

FieldSmart® Fiber Active Cabinet (FAC) 900

Installation Manual



Sealing Cable Entry Location

Seal the outside plant cable entry location(s) to protect the cabinet and Expansion Module (EXM) against moisture, dust, pests, and other contaminants. Cable entry locations with or without outside plant cable must be sealed. Use a silicon-based sealant or comparable compound.

Warning ! Seal the cable entry location immediately after outside cables are installed to prevent ground moisture from condensing inside the cabinet and damaging equipment.

Failure to take these preventive measures will void cabinet warranty.



ALERT! The sealant package does not require tools to open or mix the compound. Do not insert tools into the plastic nozzle or pierce the sealant package.

To seal the cable entry location

- Step 1:** Remove the cabinet or EXM rear access panel to access the cable entry location, if needed. From outside the compartment, use a 5/32 hex security driver to remove the eight tamper resistant screws anchoring each panel to the compartment wall.
- Step 2:** Locate the package of sealant compound in the installation kit.
- Step 3:** Mix the sealant compound inside its package per the manufacturer instructions printed on the package.
- Step 4:** Apply the sealant around open area in the entry duct where the outside plant cables/conduit enter the cabinet. Seal all gaps around the cables, inside and outside of the conduit. Follow the manufacturer's instructions to apply the sealant.



CAUTION! Check to ensure that all gaps are completely sealed. Gaps allow penetration of moisture, insects, rodents, and other contaminants that could damage equipment.



FieldSmart® Fiber Active Cabinet (FAC) 900

Installation Manual

Chapter 7: Turning Up the Cabinet Power System

This chapter describes how to turn up and test the cabinet power system.

This process includes checking the cabinet ground connection, checking the AC power supply voltage, installing rectifier modules into the rectifier shelf, installing batteries for reserve power, and turning up and testing the DC power system.

Topics Covered

This chapter covers the following topics:

- Turning up the cabinet power system (local power)

FieldSmart® Fiber Active Cabinet (FAC) 900

Installation Manual



Turning Up the Power System (Local Power)

This section describes how to turn up and test the power system for locally-powered cabinets. The process includes checking the cabinet ground connection, checking the AC power supply voltage, installing batteries for reserve power, and turning up and testing the DC power system.

Topics Covered

This chapter covers the following topics:

- Checking the cabinet ground connection
- Checking the AC power supply voltage
- Installing rectifier modules into the rectifier shelf
- Installing batteries for reserve power
- Turning up and testing the DC power system

Checking the Ground Connection

Check the impedance of the cabinet ground connection before turning up the cabinet power system.

Note: The following procedure does not test the quality of the earth ground circuit (earth electrode), which should have been installed and tested before the cabinet was installed.

To check the cabinet ground connection

Step 1: Using an ohm meter, test between the main ground bar and the earth ground wire:

- a. Place one lead on the main cabinet ground bar.
- b. Place the other lead on the earth ground wire.

Step 2: Verify that the ohm meter reads 5 ohms or less.

Step 3: If the reading is greater than 5 ohms, check the ground wire connection at the main ground bar, then retest.



FieldSmart[®] Fiber Active Cabinet (FAC) 900

Installation Manual

Checking the AC Power Supply Voltage

The cabinet ships from the factory equipped to support 208-240 VAC service. Check the AC power supply voltage as follows.



DANGER! High voltage may be present. Only a qualified electrician should perform these procedures.

To check 208-240 VAC power supply voltage

Step 1: Apply AC power to the cabinet at the local power transfer switch.

Step 2: At the cabinet AC load center, do the following:

- a. Remove the front panel from the AC load center.
- b. Switch the 30A Main breaker to **ON**.

Step 3: Using a volt meter, test between the L1 and neutral busses:

- a. Place one lead on the L1 buss.
- b. Place the other lead on the neutral buss.
- c. Verify that the volt meter reads between 110 and 120 VAC.

Step 4: Using a volt meter, test between the L2 and neutral busses:

- a. Place one lead on the L2 buss.
- b. Place the other lead on the neutral buss.
- c. Verify that the volt meter reads between 110 and 120 VAC

Step 5: Using a volt meter, test between the L1 and L2 busses.

- a. Place one lead on the L1 buss.
- b. Place the other lead on the L2 buss.
- c. Verify that the volt meter reads between 208 and 240 VAC.

Step 6: Switch the branch breakers on as follows:

- Switch the 10A Conv Outlet breaker to **ON**.
- If you are using an optional battery heater, switch the 5A Battery Heater breaker to **ON**.

Note: Do not switch on the 20A Rectifier breakers at this time.

Step 7: Re-attach the front panel on the AC load center.

Step 8: Verify that the LEDs on the surge arrester are lit and green.

FieldSmart® Fiber Active Cabinet (FAC) 900

Installation Manual



Installing the Rectifier Modules

The FAC 900 cabinet uses the Alpha Cordex HP 1.2kW 1RU rectifier shelf to generate and distribute -48 VDC bulk power. The 1RU Alpha shelf consists of a 19-inch rectifier shelf with integrated GMT fuse distribution.

The Alpha shelf supports three rectifier modules. Normal operation for the FAC 900 cabinet requires three 1200W (25A) rectifier modules, which includes 1+1 rectifier redundancy. The Alpha shelf provides integrated distribution, with 8 GMT fuse positions for equipment. The Alpha shelf is equipped with a Cordex CXCM1+ controller module that monitors power functions and alarm information and regulates voltage in response to battery temperature. The controller module ships pre-programmed for operation in the FAC 900 Power Hub. For a complete description of the controller module, refer to the Cordex Controller Software Manual. Install Alpha modules into the power shelf as described below.



Note: The controller module ships installed in the rectifier shelf. Push firmly on the controller module to verify that it is fully seated in the slot

To install a rectifier module

- Step 1:** Unpack the rectifier module.
- Step 2:** Insert the module in a vacant slot, sliding the module into the rear connector (inside of the shelf). Populate slots top to bottom (shelf oriented vertically).
- Step 3:** Apply pressure on the front of the module to engage the rear connector in the shelf receptacle. The module has a locking latch to secure the rectifier into the shelf.

Note: Do not force a module into position if it does not seat properly. All modules are keyed to ensure that the correct module type is used.

- Step 4:** Repeat steps 1–3 to install additional rectifier modules.



FieldSmart® Fiber Active Cabinet (FAC) 900

Installation Manual

Installing VRLA Batteries

The FAC 900 cabinet can house a primary single string of front-terminal 100Ah VRLA (four batteries per string). A cabinet equipped with an optional Expansion Module (EXM) can support a secondary or alternative location for the battery string. See *Supported Batteries* for a list of supported battery types.

This topic provides instructions for the following tasks:

- Preparing batteries for installation
- Installing a 100Ah VRLA battery string



WARNING! Electrical hazard. Batteries contain a stored charge. Only a qualified technician should perform this procedure.



CAUTION! Electrical, chemical, fire, and heat hazard. Handle batteries with care to avoid personal injury or damage to the equipment.



ALERT! Read the battery manufacturer's instructions before installing batteries. Follow the manufacturer guidelines and local safety practices.

To prepare batteries for installation

- Step 1:** Unpack the batteries from the shipping packaging.
- Step 2:** Remove the terminal caps from the top of each battery.
- Step 3:** Clean and apply No-Ox anti-corrosion grease to each battery terminal.
- Step 4:** Locate the bagged kit containing the string jumper straps and other materials. Set the kit aside for use during installation.

Note: *If you are using the optional battery heater, install the heater before installing batteries. See *Installing a Battery Heater* for instructions.*



WARNING! In -48V telecom systems, red leads connect to the negative terminal and black leads connect to the positive terminal. Do not reverse the wiring polarities.



CAUTION! Both sides of the Anderson connectors are hot.

FieldSmart® Fiber Active Cabinet (FAC) 900

Installation Manual



To install 100Ah VRLA batteries

Step 1: Open the side FAC 900 cabinet or EXM front door.

Step 2: Remove the vent cover from the side door, if present:

- a. Remove the (4) pan head Phillips screws from the vent cover, and set aside.
- b. Remove the vent cover.
- c. Reinstall the (4) screws.

Note: The screws secure both the vent cover and solar shield in place, and must be reinstalled for the solar shield.

Step 3: At the front of the seismic retaining bracket, disconnect the #8 AWG battery power cables from the power supply leads (if connected).



Step 4: Open the latch on each side of the terminal cover and remove the cover.

Step 5: Remove the seismic retaining bracket from the internal battery enclosure as follows:

- a. Remove the (2) hex head screws and washers from each side of the retaining bracket.
- b. Rotate the retaining bracket forward, and lift the bracket from the groove at the base of the battery enclosure.
- c. Place the retaining bracket within close proximity of the enclosure (the battery power cables are connected to the front of the bracket).

Step 6: Place a string of four batteries into the battery enclosure, with the terminals in front.

Step 7: Install the jumper straps between the battery terminal posts per the manufacturer instructions.



FieldSmart® Fiber Active Cabinet (FAC) 900

Installation Manual

Step 8: Connect the battery power supply leads as follows:

- Remove the protective caps from the cable ring lugs.
- Attach the black cable that is routed through the right upper hole in the retaining bracket to the positive (+) terminal post at the right end of the string.
- Attach the red cable that is routed through the left upper hole in the retaining bracket to the negative (-) terminal post at the left end of the string.



ALERT! Use a volt meter to verify correct wiring polarities.

- Mount the temperature probe cable lug onto the string's negative (-) terminal post at the left end of the string.
- Tighten the hardware on the terminal posts to the torque specified by the manufacturer.
- If available, install protective covers (manufacturer-supplied) over the battery terminals.

Step 9: Replace the retaining bracket and terminal cover.

Step 10: Connect the Anderson power connectors together.

To connect a temperature probe cable to the cabinet power system (for VRLA batteries only)



WARNING! Risk of electric shock. Only a qualified electrician should perform this task.

Note: Two temperature probe cables are pre-wired to the rectifier, labeled **1** and **2**.

Step 1: Mate the temperature probe cable from the primary battery string with the rectifier cable labeled **1**.

Step 2: For a secondary battery string, route the rectifier cable labeled **2** to the battery enclosure, and then mate the temperature probe cable with the rectifier cable.

Step 3: Connect the terminal ring sensor end to the red (-) battery terminal.

FieldSmart® Fiber Active Cabinet (FAC) 900

Installation Manual



Turning Up and Testing the DC Power System

Turn up and test the cabinet DC bulk power system as described below.

To turn up and test the DC power system

Step 1: At the AC load center, verify that the Main breaker is **ON**.

Step 2: At the AC load center, switch the (2) 20A Rectifier breaker **ON**.

Step 3: Verify that the rectifier shelf boots up and the rectifier modules are operational.

Note: The Alpha shelf controller is factory programmed with default settings that enable safe power up and operation. You can modify the settings for system voltages, battery configuration, temperature compensation, and so forth, if required. For programming instructions, refer to the Alpha Cordex Controller Software Manual.

Step 4: Verify that the rectifier shelf controller has acquired the rectifier modules as follows:

- a. Connect a laptop to the CXCM1+ Ethernet port using a standard network cable.
- b. Laptop IP Network settings (**Start > Control Panel**):
 - IP address: 10.10.10.202
 - Subnet Mask: 255.255.255.0
- c. Turn off the pop-up blocker.
- d. Open an IE browser and set the browser to run in compatibility mode.
- e. In the Web address bar, enter the IP address of the Alpha controller module (10.10.10.201).
- f. Log into the controller module:
 - Username: Your initials or other unique identifier
 - Password: 1234
- g. Enter the language selection: English
- h. From the Controller screen (Controller > Date & Time), set the correct date and time.



FieldSmart® Fiber Active Cabinet (FAC) 900

Installation Manual

i. On the System screen (System > View Live Status), check that the installed rectifiers have been acquired by the controller by verifying the number associated with "# Acquired Rectifiers".

System > View Live Status

Mains	
Avg AC Voltage:	210.9V
Avg. AC Phase R:	---
Avg. AC Phase S:	---
Avg. AC Phase T:	---

Rectifiers	
Output Current:	1.88A
Mode:	FL+TC
# Acquired Rectifiers:	2
# Power Saving Rectifiers:	0

Load	
Load Voltage:	54.31V
Load Current:	1.9A

Converters	
Device Name:	
Output Current:	---
Output Voltage:	---
# Acquired Conv.:	---

LVD	
Activated LVDs:	0
Enabled LVDs :	0

Batteries	
Battery Voltage:	54.31V
Battery Current:	0.0A
Battery Temperature:	20.38°C
Battery Runtime:	---
Battery Capacity:	100.0%
Battery DOD:	---

LPS	
# Acquired LPS	2

Note: Alarm conditions may be present and will not clear due to no load conditions.

Step 5: At the 20 position fuse panel, do the following:



Install a 2A GMT fuse in position 20 and verify that the heat exchanger fans start running (if internal temperature is high enough).

FieldSmart® Fiber Active Cabinet (FAC) 900

Installation Manual



Testing Batteries

If the batteries are not fully charged, perform this procedure after charging the batteries



WARNING! Electrical hazard. Only a qualified technician should perform these procedures.

To test the batteries

- Step 1:** Using a digital volt meter, test the battery connection between the negative and positive battery leads:
- Place the red volt meter lead on the red negative (-) battery lead.
 - Place the black volt meter lead on the black positive (+) battery lead.
 - Verify that the volt meter reads between -46 and -54 VDC.
 - Measure the voltage difference between the power system and the battery string. The voltage difference should be less than 3V. If the voltage difference is greater than 3V, check for connection integrity, replace bad battery cell as applicable, and retest the voltage.
- Step 2:** Verify that the cabinet heat exchanger fans are running (if the temperature is high enough).
- Step 3:** At the AC load center, set the Main breaker to **OFF**. The heat exchanger fans should continue to run.
- Step 4:** At the AC load center, set the Main breaker to **ON** and verify that power restores to the rectifier shelf.

Changing CXCM1+ Controller Battery Charge Current Settings

The CXCM1+ battery charge current control algorithm limits the amount of charge current available to the batteries. It is imperative that the battery parameters and charge current are set appropriately relative to the installed battery capacity. The default controller setting for battery capacity is 60Ah and charge rate C/6 (10A).

- Step 1:** Connect to the controller as follows:
- Connect a laptop to the CXCM1+ Ethernet port using a standard network cable.
 - Laptop IP Network settings (**Start > Control Panel**):
 - IP address: 10.10.10.202
 - Subnet Mask: 255.255.255.0



FieldSmart® Fiber Active Cabinet (FAC) 900 Installation Manual

- c. Turn off the pop-up blocker.
- d. Open an IE browser and set the browser to run in compatibility mode.
- e. In the Web address bar, enter the IP address of the Alpha controller module (10.10.10.201).
- f. Log into the controller module:
 - Username: Your initials or other unique identifier
 - Password: 1234

Step 2: Change the battery parameters:

a. Navigate to **Batteries > Configure Batteries**

b. In the Battery Properties box, enter the sum of the battery string capacities into the Capacity Rating field box (for example, enter 180Ah for one string of 180Ah batteries; enter 360Ah for two strings of 180Ah batteries, etc.).

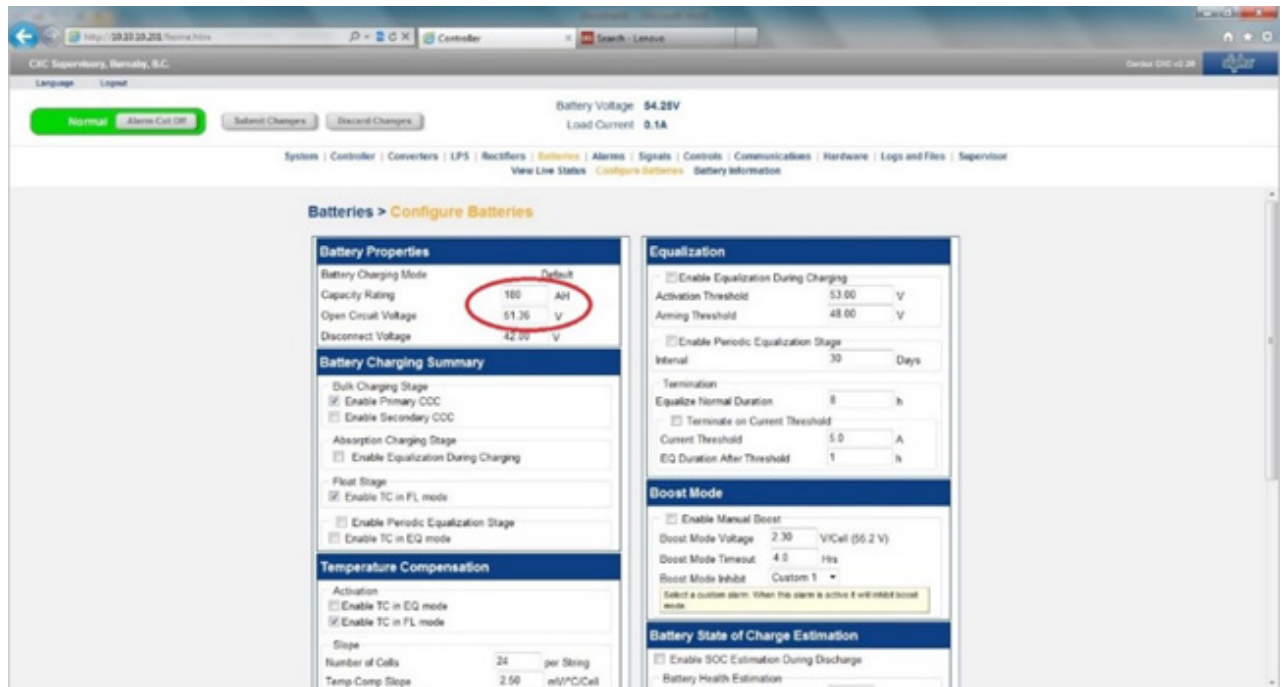

c. Scroll further down the page to the Charge Current Control box. The charge rate can be entered either in terms of Charge Amps or the C/X charge rate. Enter the desired charge rate in either format into the respective field box.

FieldSmart® Fiber Active Cabinet (FAC) 900 Installation Manual



d. Ensure the **Enable Primary CCC** check box is checked.

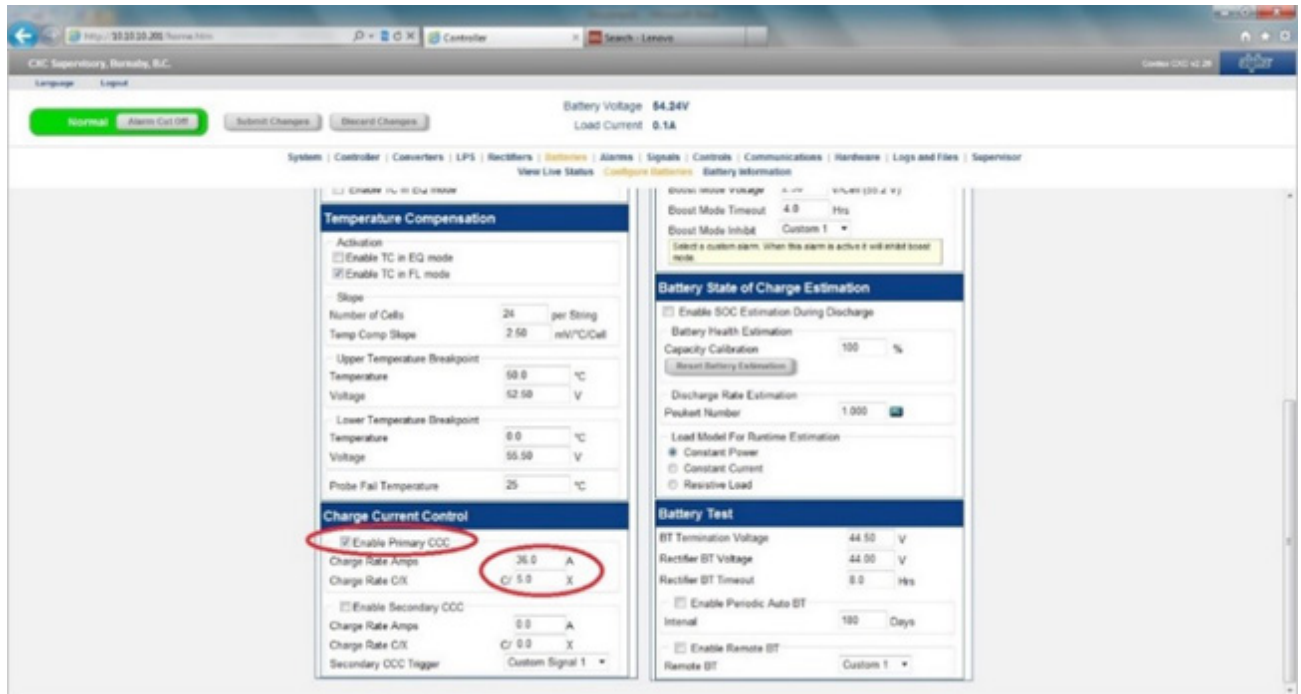

Step 3: Submit and save the changes to the charge current control settings.

a. At the top left side of the page, click the **Submit Changes** button. A pop-up window will be displayed comparing the old settings and the new settings.

b. Select the changes and click the **Accept** button in the lower right corner of the pop-up window.

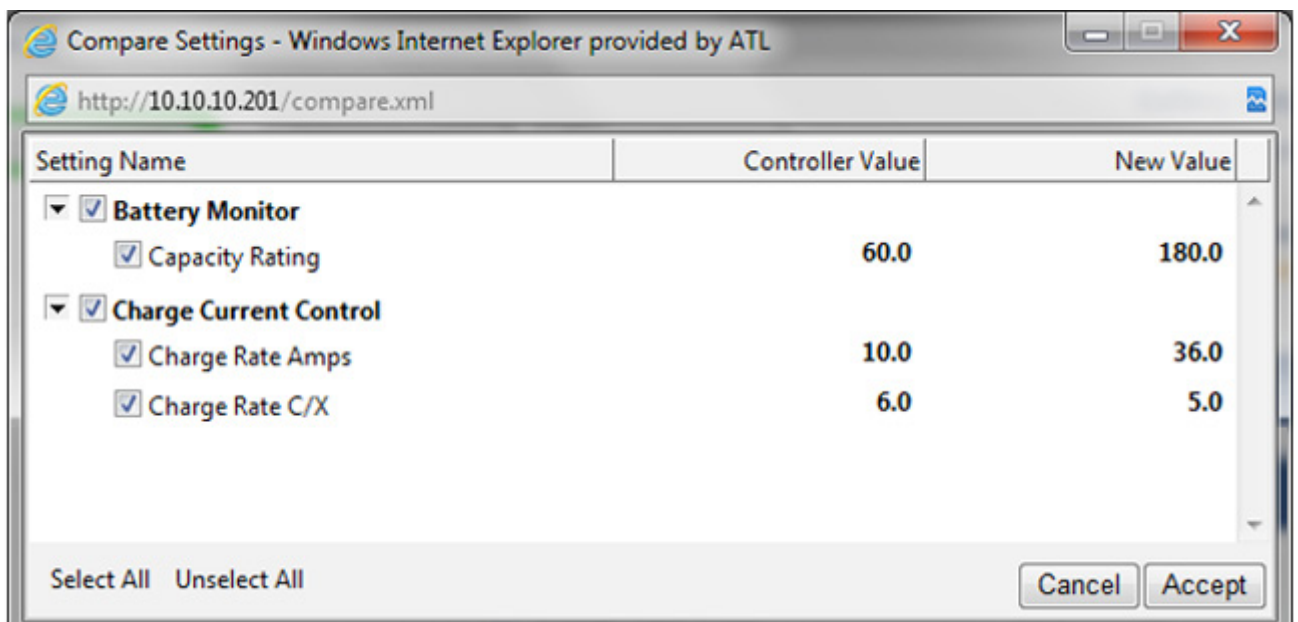



FieldSmart® Fiber Active Cabinet (FAC) 900

Installation Manual

Step 4: Change the High Battery Current Alarm setting as follows:

- Navigate to **Alarms > Configure Alarms**.
- In the alarm configuration drop down box, select **Current Alarms**.
- Change the **Battery Current High** and **Load Current High** alarms to the desired value.

CXC Supervisory, Burnaby, B.C. Cortex CXC v2.26

Language Logout Battery Voltage **54.23V**
Load Current ---

Minor Alarm Cut Off Submit Changes Discard Changes

System | Controller | Converters | LPS | Rectifiers | Batteries | **Alarms** | Signals | Controls | Communications | Hardware | Logs and Files | Supervisor

View Live Status [Configure Alarms](#) Global Alarm Configuration

Alarms > Configure Alarms

Alarm Configuration Current Alarms

Alarm Name	Value	Unit	Enable	Priority	Relay Mapping	Alarm Cut Off	Email	SNMP	Severity
Battery Current High	30	A	<input checked="" type="checkbox"/>	Major	N/A	<input checked="" type="checkbox"/>	<input checked="" type="checkbox"/>	<input checked="" type="checkbox"/>	0
Load Current High	50	A	<input checked="" type="checkbox"/>	Major	N/A	<input checked="" type="checkbox"/>	<input checked="" type="checkbox"/>	<input checked="" type="checkbox"/>	0

- Submit and save the changes as shown above.

Chapter 8: Installing Equipment and Adding Capacity

This chapter describes how to install optional equipment and components into the cabinet and Expansion Module (EXM), including expansion components to increase system capacity. The cabinet and EXM allow for modular growth of line capacity and supports field installation of all factory options.

Topics Covered

This chapter covers the following topics:

- Installing a protection mounting frame
- Installing a protection block
- Installing a cross-connect panel
- Installing an external splice compartment
- Installing an battery enclosure
- Installing a battery heater
- Installing a power buffer capacitor
- Installing a generator connector
- Installing a heat exchanger door
- Installing fiber management options
- Installing a GPON splitter cage and fiber distribution bulkhead frames
- Connecting PON splitter fibers to the OLT equipment
- Installing fiber termination assemblies (equipped with cassettes and pre-terminated OSP fiber cable)
- Installing PON splitter assemblies and fibers
- Installing a dual LGX fiber distribution panel

For ordering information, contact your Clearfield Sales Representative.



FieldSmart® Fiber Active Cabinet (FAC) 900

Installation Manual

Installing a Protection Mounting Frame

The FAC 900 copper line protection system allows you to expand line capacity incrementally. Protection blocks are housed in a mounting frame that installs on a 23-inch rack. Each mounting frame holds up to eight 50-pair protection blocks. You can field-install protection mounting frames to expand system capacity. The protection system resides in the cabinet and/or EXM.

To install an 8 position 50-pair protection mounting frame

- Step 1:** Unpack the protection mounting frame from its packaging.
- Step 2:** Verify that two ground wires are connected to the mounting frame. Install the ground wires if necessary.
- Step 3:** Install the protection mounting frame on the rack as follows.
- a. Turn the (2) knobs on the frame counter-clockwise (to the latch's disengaged position).
 - b. Position the frame against the rack, oriented with the hinge on the right side.

Note: *To correctly align the frame for mounting, the hinge must align with mounting holes on the right rack, and the alignment pin on the left side must insert into a mounting hole on the left rack.*

- c. When the mounting frame is aligned correctly, secure the hinge side to the right rack using (4) self-tapping screws.
- d. While holding the swing frame closed against the rack, turn the (2) knobs clockwise to engage the latch, thereby securing it in the closed position.

Route the two frame ground wires to the main ground bar. Attach the ground wire lugs to an open position on the main ground bar or subground bar per PANI guidelines. Refer to *Installing the Cabinet Ground Connection* for more information.

FieldSmart® Fiber Active Cabinet (FAC) 900

Installation Manual



Installing a Protection Block

You can increase the cabinet's copper line protection capacity in the field to support expansion equipment. Protection blocks are housed in mounting frames that each hold up to eight 50-pair blocks.

Note: Clearfield equipment uses a 'dead pair' scheme, where the 25th pair on each subscriber interface and in each 25-pair cable group is unterminated (dead). Therefore, on each protection block, positions 25 and 50 are not wired. Line identification labels cover the dead pair positions (25 and 50).

To install a protection block

- Step 1:** Unpack the protection block from the shipping packaging.
- Step 2:** On the back of the protection block, remove any cable ties that coil up the interface cables (two with MS2 or 710 connectors, two with RJ-21 connectors).
- Step 3:** In the cabinet or EXM, locate the next open position on the protection mounting frame, then feed the block's interface cables through the fixture into the area behind it. Populate protection blocks from left to right on the frame.

Note: For equipment overlay service units, where the line protection for the user and overlay lines is split across two adjacent 50-pair blocks, typically the block on the left protects the PSTN (overlay) lines, while the block on the right protects the user (DSL) lines.

- Step 4:** Attach the protection block to the mounting frame as follows:



- a. Insert the tabs on the left side of the block into the slots on the mounting frame.



FieldSmart® Fiber Active Cabinet (FAC) 900

Installation Manual

- b. Pull down the spring-loaded plunger latch on the right side of the protection block. While holding the plunger down, rotate the block back into its mounting position. Release the plunger latch to secure it in the mounting fixture.
- c. Install two supplied screws into the left side of the block to secure it to the frame. (The screws provide a critical ground path to the cabinet's main ground bar or EXM's subground bar.)

Step 5: Terminate the protection block interface cables as follows:

- a. Route the two RJ-21 equipment interface cables into the main compartment and connect to the Clearfield service unit's RJ-21 connectors.
- b. Mate the two MS2 or 710 subscriber interface cables to the counterpart OSP interface cables.
- c. Dress and secure the interface cables to the rack or towel bars as needed.

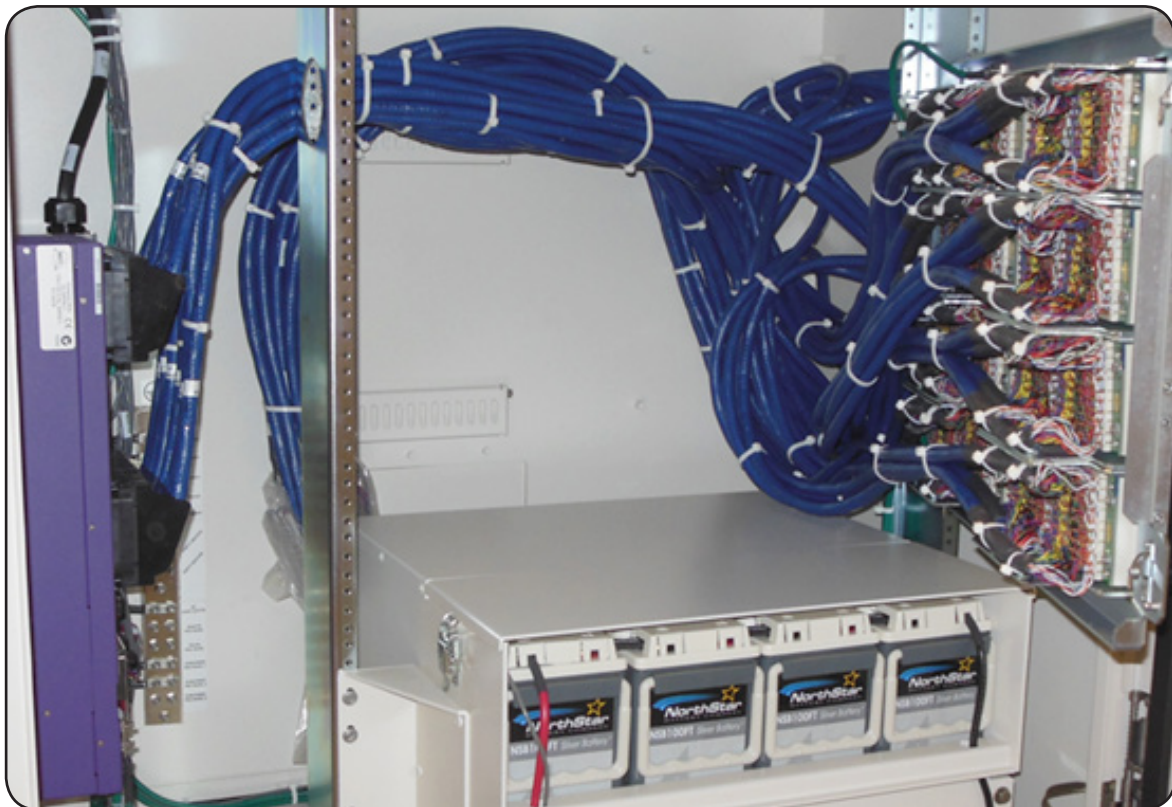

Step 6: Apply line identification labels over the protection block's dead pair positions (25, 50).

- Use the blue labels to identify user lines (POTS/xDSL).
- If applicable, use the green labels to identify PSTN overlay lines.

Step 7: Repeat Steps 1–6 to install additional protection blocks for lines served (adjacent to the first), as needed.

FieldSmart® Fiber Active Cabinet (FAC) 900

Installation Manual



TE LSA-Plus Cross-Connect System

This section describes how to install a standard 2:1 TE LSA-Plus cross connect system into an EXM (768 subscriber/384 equipment pairs). To allow for incremental growth, the cross-connect system is comprised of two modular panels, each supporting 384 subscriber and 192 equipment pairs, arranged in 50-block pairs.

Note: All Clearfield cabling uses a 'dead pair' scheme, where the 25th pair in each 25-pair cable group is unterminated and not used (dead).

For cabinets already in service, installing a cross-connect panel will affect service to subscribers, because the cross-connect panel sits inline between the cabinet's copper line protection and the OSP ('subscriber' side) cables. Clearfield recommends performing the installation during a maintenance window to minimize the service impact.



CAUTION! Installing a cross-connect panel requires safe handling to ensure that no injury to personnel or damage to equipment occurs.

To install a cross-connect mounting frame

Step 1: Unpack the cross-connect mounting frame from the shipping package, and open the EXM door.

Step 2: Install the (2) crossbars on the equipment rack as follows:

- a. Orient a crossbar horizontally between the equipment rails as shown in the diagram below, 13-inches from the bottom of the cabinet.
- b. Secure the lower crossbar to the equipment rack using (4) self-tapping screws.
- c. Orient a crossbar horizontally between the equipment rails, measuring 17.75-inches from the inside of the lower crossbar to the inside of the upper crossbar.
- d. Secure the upper crossbar to the equipment rack using (4) self-tapping screws.

Step 3: Install the rail on the crossbars as follows:

- a. Center the rail vertically between the crossbars.
- b. Secure the rail to the crossbars using (4) self-tapping screws.



FieldSmart® Fiber Active Cabinet (FAC) 900

Installation Manual

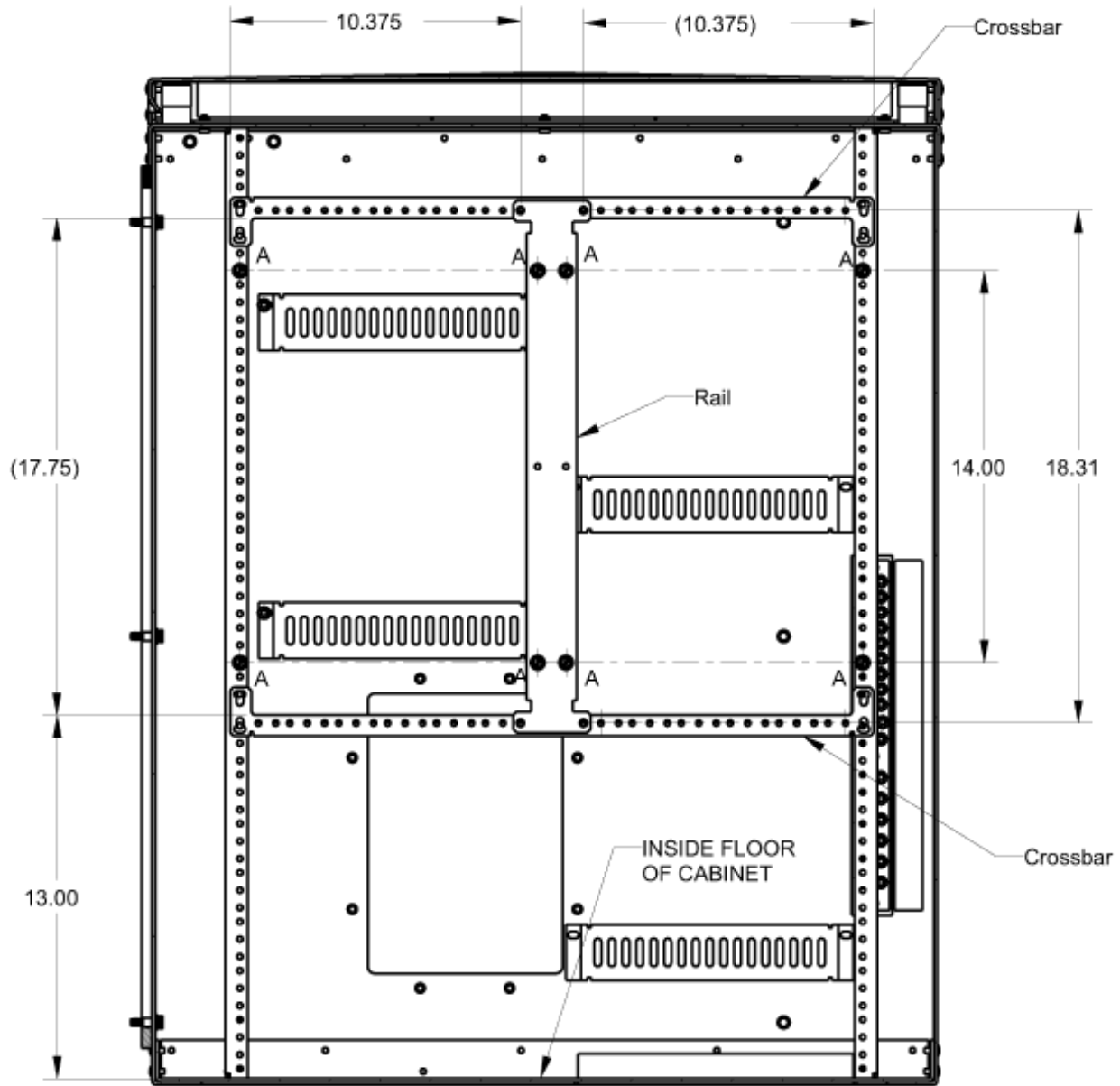

To install a cross-connect panel

- Step 1:** Unpack the cross-connect panel from the shipping package, and open the EXM door.
- Step 2:** Mount the test tool holder on the (4) studs located on the interior door, and secure using (4) Keps nuts.

Note: One test tool holder ships with each cross-connect panel; only one test tool holder is required per enclosure.

- Step 3:** At the right side of the cross-connect frame, partially insert (4) self-tapping screws, leaving a .25-inch gap between the frame and screw as shown in the diagrams below.

FieldSmart® Fiber Active Cabinet (FAC) 900

Installation Manual

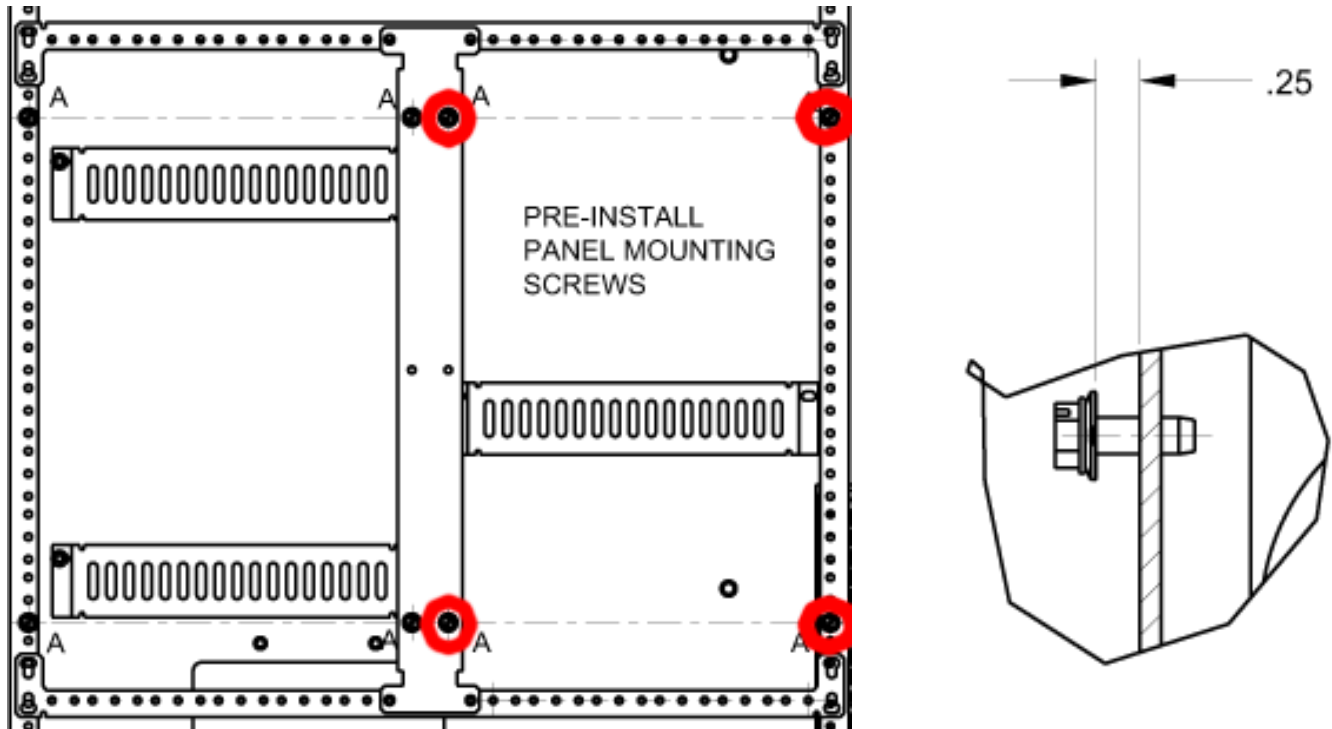

Step 4: Place the pad from the shipping package at the base of the enclosure under the cross-connect frame on the right side.

Step 5: Prepare the cross-connect panel for installation as follows:

a. Separate the subscriber cables and the equipment cables. (The cables are labeled 'Subscriber' and 'Equipment'.)

Note: To ease installation, it may be advantageous to remove some of the cable bundle tie wraps in some applications.

b. Orient the panel face down with the bottom of the panel toward the rear of the enclosure, and then route the cables under the cross-connect frame.

c. Lay the cross-connect panel on the pad.

Step 6: Terminate the cables as follows:

a. Mate the equipment-side cables to the appropriate protection panel interface cables (MS² or 710 connectors), toward the left access panel.

b. Mate the subscriber-side cables (193-384) to the appropriate OSP interface cables (MS² or 710 connectors), toward the rear access panel.



FieldSmart® Fiber Active Cabinet (FAC) 900

Installation Manual

- Step 7:** Dress and secure all cables with tie wraps against the rear wall.
- Step 8:** Install the cross-connect panel as follows:
- Lift the panel up toward the frame, and slide the panel keyholes over the (4) screws that were pre-installed in step 3.
 - Use a long extension power drill to tighten the screws.
- Step 9:** Remove the pad from the base of the enclosure.
- Step 10:** Repeat steps 2–8 to install a second cross-connect panel, adjusting the steps as necessary to install a panel for subscribers 1-192 on the right side of the cross-connect frame.



FieldSmart® Fiber Active Cabinet (FAC) 900

Installation Manual



Installing an AC Meter

You can secure a commercial AC power meter and main disconnect boxes to customer-supplied Unistrut® metal framing installed on the exterior of the cabinet. Use the (6) mounting studs located on the left side wall (to the right of the access panel) to install the Unistrut.

For AC wiring information, refer to the AC wiring diagram on the inside cabinet wall.



DANGER! High voltage may be present. Only a qualified electrician should install an AC meter. Follow NEC and local codes when handling power systems.

The figure below shows the mounting location for the Unistrut metal framing:

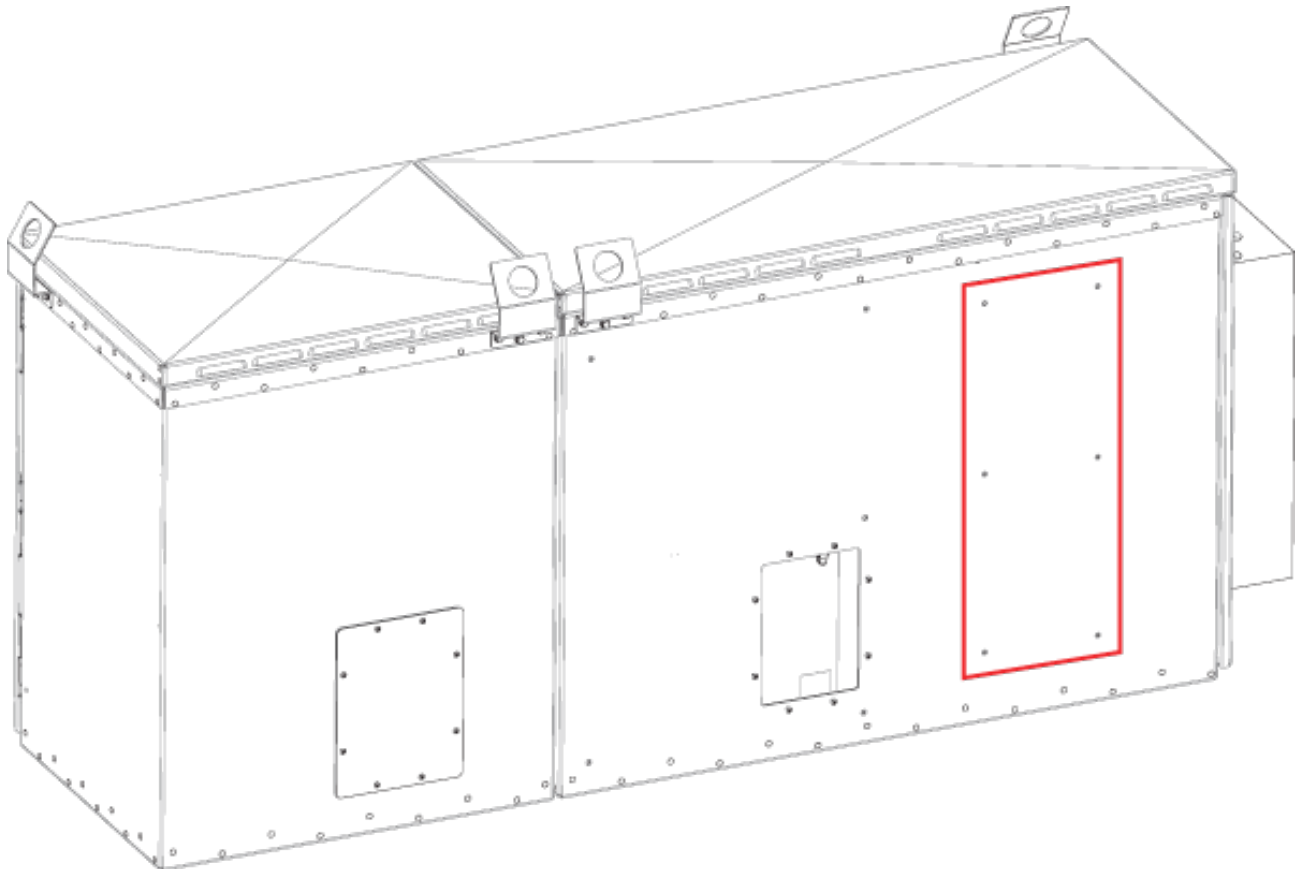



FieldSmart® Fiber Active Cabinet (FAC) 900

Installation Manual

Installing a Battery Enclosure

Clearfield supports field installation of a primary or secondary internal battery enclosure in the FAC 900 cabinet, EXM or FAC 900 cabinet battery riser. Battery enclosures are available for 100Ah VRLA or Ni-Cd battery strings.

To install a battery enclosure

- Step 1:** Unpack the battery enclosure from the shipping packaging, and open the side FAC 900 cabinet or front door of the FAC 900 cabinet battery riser or the EXM.
- Step 2:** Place the battery enclosure in base of the FAC 900, battery riser or EXM, aligning the mounting bracket holes against the counterpart holes on the equipment rack.
- Step 3:** Install the eight mounting screws (4 per side) to secure the enclosure to the rack. Tighten the screws to 45 in. lbs. of torque (enclosure for VRLA battery string shown below).



- Step 4:** Ensure that the front bottom edge of the enclosure is up against the inside lip of the door jam. If not, loosen the screws that mount the rails to the top and bottom of the FAC 900 or EXM, pull the battery enclosure forward, and then re-tighten the screws.
- Step 5:** Close the door and check to be sure that the battery housing properly seals against the door gasket. For the FAC 900, this can be viewed through the front equipment compartment; for the EXM, this can be viewed through the rear access panel using a flashlight.

FieldSmart® Fiber Active Cabinet (FAC) 900

Installation Manual



Installing a Battery Heater

For colder climates, Clearfield recommends using an optional battery heater to prevent VRLA batteries from freezing and to prolong battery life. A battery heater supports one VRLA battery string. Ni-Cd battery strings do not require a battery heater.

The battery heater is controlled by a thermostat set for the following operation:

4° C – Battery heater turns On.

16° C – Battery heater turns Off.

Note: *The battery heater sits directly underneath the battery string. You must install the heater into the battery enclosure before installing batteries.*

To install a battery heater in an FAC 900 battery enclosure

Step 1: Unpack the battery heater from the shipping packaging.

Step 2: Open the side cabinet door.

Step 3: Install the mounting bracket for the battery heater jumper cable as follows:

- a. Position the bracket against the left equipment rack, aligning the bottom bracket hole with the counterpart hole on the rack immediately above the internal battery enclosure.
- b. Install (2) mounting screws to secure the bracket to the rack.

Step 4: Remove the seismic retaining bracket from the battery enclosure as follows:

- a. Remove the (2) hex head screws and washers from each side of the retaining bracket.
- b. Rotate the retaining bracket forward, and lift the bracket from the groove at the base of the battery enclosure.

Step 5: Install the battery heater into the battery tray in the internal battery enclosure as follows:

- a. Orient the battery heater with the heating element and alignment tabs on the bottom (face down) and the power and ground wires on the left side.
- b. Route the heater power and ground wires through the left rear hole of the battery enclosure.
- c. Place the heater into the battery tray, aligning the heater tabs into the slots in the tray.



FieldSmart® Fiber Active Cabinet (FAC) 900

Installation Manual

Step 6: Connect the heater power and ground wires as follows:

- a. Route the ground and power wires from the rear of the battery enclosure to the mounting bracket installed in step 3.
- b. Attach the ground wire to the mounting stud located on the bracket using the supplied Keps nuts and star washers.
- c. Snap the power cord face-up into its cutout in the mounting bracket installed in step 3.

Step 7: (AC load center) Install the battery heater jumper cable as follows:

- a. Snap the jumper cable's power connector face down into its cutout in the mounting bracket installed in step 3.
- b. Route the jumper cable to the rear of the AC load center and feed it through the cord grip in the AC input hole.
- c. Attach the supplied fast-on lug to the stripped end of the black wire, and then connect the terminated black wire to the load terminal of the 5A Battery Heater breaker.
- d. Connect the white lead to the Batt Htr position on the panel board Neutral bar.

Note: An AC wiring label is attached behind the load center front panel for reference.

- e. Tighten the cord grip around the jumper cable at the rear of the load center.

Step 8: (AC junction box) Install the battery heater jumper cable as follows:

- a. Snap the jumper cable's power connector face down into its cutout in the mounting bracket installed in step 3.
- b. Route the jumper cable to the rear of the AC junction box and feed it through.
- c. Connect the L1 (black) and N (white) leads to the (Optional) Battery Heater terminal block position.

Note: An AC wiring label is attached behind the junction box front panel for reference.

- d. Tighten the cord grip around the jumper cable at the rear of the junction box.

Step 9: After the batteries are installed, apply power as follows:

Note: For battery installation instructions, see *Installing Batteries*.

- a. At the AC load center, switch **ON** the 5A Battery Heater breaker, or
- b. Switch on the 5A Battery Heater breaker at the external power source that feeds the AC junction box.

FieldSmart® Fiber Active Cabinet (FAC) 900

Installation Manual



To install a second battery heater in an EXM battery enclosure

Note: This procedure assumes that you have installed a battery heater in the FAC 900 battery enclosure.

- Step 1:** Unpack the battery heater from the shipping packaging.
- Step 2:** Open the EXM door.
- Step 3:** Install the mounting bracket for the battery heater jumper cable as follows:
- Position the bracket against the equipment rack, aligning the bottom bracket hole with the counterpart hole on the rack immediately above the internal battery enclosure.
 - Install (2) mounting screws to secure the bracket to the rack.
- Step 4:** Install the second string battery heater jumper cable as follows:
- Locate the battery heater power cable installed in the primary FAC 900 battery enclosure.
 - Disconnect the primary battery heater power cable connector from the panel mounted connector located on the mounting bracket above the FAC 900 battery enclosure.
 - Connect the AC connector on the second string jumper cable to the face down panel mounted connector from the AC load center (or AC junction box) located on the mounting bracket above the FAC 900 battery enclosure.
 - Connect the second string jumper cable's battery heater 1 connector to the primary battery heater power cable connector that you disconnected in step 4b.
 - Route the second string jumper cable's battery heater 2 connector branch into the EXM and snap it face down into its cutout located on the mounting bracket above the EXM battery enclosure.

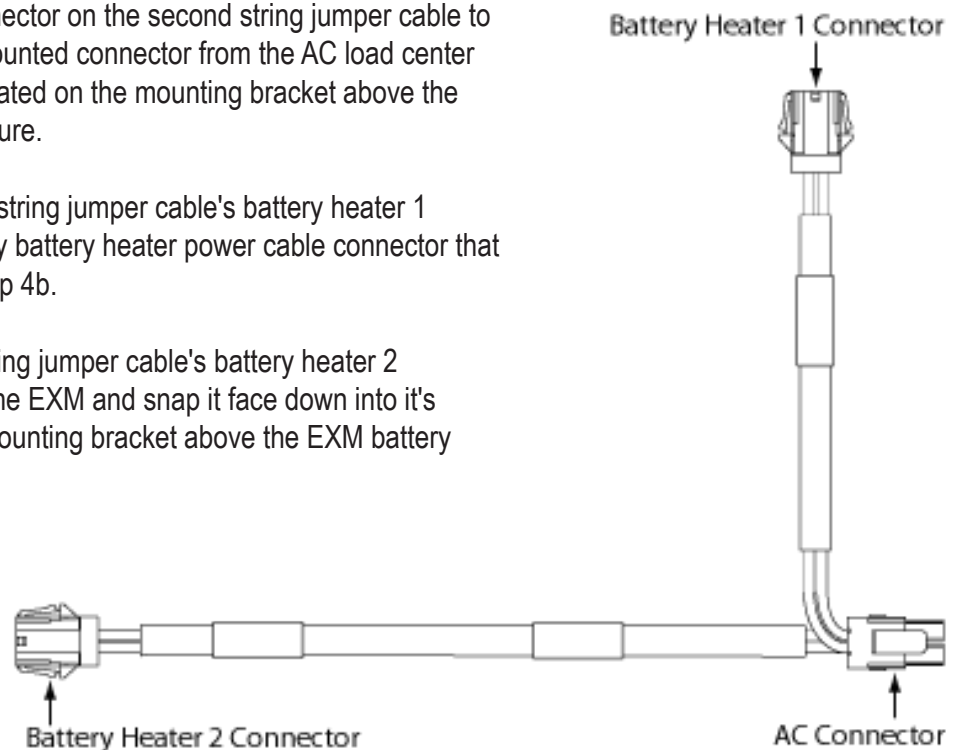



FieldSmart® Fiber Active Cabinet (FAC) 900

Installation Manual

- Step 5:** Remove the seismic retaining bracket from the EXM battery enclosure as follows:
- Remove the (2) hex head screws and washers from each side of the retaining bracket.
 - Rotate the retaining bracket forward, and lift the bracket from the groove at the base of the battery enclosure.
- Step 6:** Install the battery heater into the battery tray in the internal battery enclosure as follows:
- Orient the battery heater with the heating element on the bottom (face down) and the power and ground wires on the left side.
 - Route the heater power and ground wires through the left rear hole of the battery enclosure.
 - Drop the heater into place over the plastic insulator.
- Step 7:** Connect the heater power and ground wires as follows:
- Route the ground and power wires from the rear of the battery enclosure to the mounting bracket installed in step 3.
 - Attach the ground wire to the mounting stud located on the bracket using the supplied Keps nuts and star washers.
 - Snap the power cord face-up into its cutout in the mounting bracket installed in step 3.
- Step 8:** After the batteries are installed, apply power as follows:
- Note:** For battery installation instructions, see *Installing Batteries*.
- At the AC load center, switch **ON** the 5A Battery Heater breaker, or
 - Switch on the 5A Battery Heater breaker at the external power source that feeds the AC junction box.

FieldSmart® Fiber Active Cabinet (FAC) 900

Installation Manual



Installing a Generator Connector

A generator connector allows an external power generator to be connected to the cabinet to sustain services during an AC power outage. The cabinet supports a 30 Amp generator connector option, which you can install in the field. If the cabinet is equipped with charged batteries, this procedure does not affect service.

Note: Clearfield recommends a generator size of 240 VAC.



DANGER! High voltage may be present. Only a qualified electrician should perform this task. Follow NEC and local codes when handling power systems. Do not restore AC power until the task is complete.

To prepare for generator connector installation

Step 1: At the local power transfer switch, disconnect AC power to the cabinet.

Note: If the cabinet is equipped with charged batteries, this action does not affect service. The equipment automatically switches to battery reserve power.

Step 2: Open the front cabinet door.

Step 3: Install a circuit breaker for the Gen Conn circuit into the load center as follows:

- a. Remove the right panel from the AC load center.
- b. At the AC load center, switch the Gen Conn (if present) and Main circuit breakers to **OFF**.
- c. Install the Gen Conn circuit breaker:
 - Get the Gen Conn breaker from the shipping package.
 - Set the switch to **OFF**.
 - Insert the breaker to the right of the Main breaker.
 - Install the supplied interlock between the Gen Conn and Main breakers (DO NOT use generator input without this interlock).

Step 4: Remove the blank plate that covers the mounting fixture as follows:

- a. At the exterior side of the cabinet, use a tool for tamper-resistant fasteners to remove the (4) security screws anchoring the blank plate to the cabinet wall.

Note: Do not discard the four mounting screws. The screws will be reused to install the generator connector.

- b. Pull the blank plate away from the cabinet wall to expose the connector mounting fixture.



FieldSmart® Fiber Active Cabinet (FAC) 900

Installation Manual

To install a generator connector into an FAC 900 cabinet

Step 1: Unpack the generator connector from its shipping packaging.

Step 2: Attach the generator connector to the cabinet mounting fixture as follows:

- a. From the exterior side of the cabinet, feed the generator connector wires into the cabinet through the mounting fixture opening.
- b. Insert the generator connector into the mounting fixture, aligning the mounting holes with the counterpart holes in the fixture.
- c. Install the (4) tamper-resistant screws removed previously to attach the generator connector.

Step 3: Connect the generator connector wires to the AC load center as follows:

- a. Route the generator connector wires through the access hole in the right side of the AC load center.
- b. Terminate the generator connector wires to the load center as follows:
 - Connect the green wire to the ground bar.
 - Connect the white wire to the neutral bar.
 - Connect the black and red wires to the Gen. Conn. breaker.

Note: Refer to the AC load center wiring diagram (on Clearfield's website, see clearfield.com) for guidance. An AC wiring label is attached behind the load center front panel for reference.

Step 4: Replace the AC load center cover panel.

Step 5: Install the Gen Conn ID label on the cover panel directly under the Gen Conn 30 Amp breaker.



Step 6: At the AC load center, switch all breakers to **ON**.

Step 7: At the local power transfer switch, restore AC power to the cabinet.



Installing a Heat Exchanger Door

The FAC 900 front door is equipped with an integrated heat exchanger to cool equipment inside the cabinet. Installing a heat exchanger door in the field may become necessary if the existing door becomes damaged or the heat exchanger fails or becomes damaged.

To install a heat exchanger door on an FAC 900 cabinet

- Step 1:** Remove the existing door that is to be replaced. See *Removing a Cabinet Door* for instructions.
- Step 2:** Install the new heat exchanger door on the vacant door frame. See for *Installing a Cabinet Door* instructions.



FieldSmart® Fiber Active Cabinet (FAC) 900

Installation Manual

Installing Fiber Management Options

Clearfield FAC 900 cabinet supports GPON and AE fiber management options supporting up to 384 subscriber fiber drops with an internal battery enclosure installed, or up to 576 subscriber fiber drops for GPON applications without internal battery enclosure installed. The EXM supports equal fiber distribution configurations.

Fiber management solutions include:

- 96- and 192-position fiber distribution frames, each supporting two 48-fiber or two 96-fiber termination assemblies respectively (with pre-terminated, 100-foot OSP fiber cable) for high density point-to-point Ethernet and GPON applications
- Up to eighteen integrated 1:2, 1:16 or 1:32 PON splitters (and integrated cage) for GPON applications
- 12-, 24-, 48- or 96-position fiber splice and distribution panels (19-inch mount)
- 6- and 12-position dual LGX fiber distribution panel (19- or 23-inch mount)
- Fiber management accessories (fiber dressing spools and comb)



FieldSmart® Fiber Active Cabinet (FAC) 900

Installation Manual



The fiber termination assemblies are offered as field installed options only. Fiber distribution frames and fiber management accessories are offered as factory integrated and field installed options. You can order and install individual components to scale support as required. Additionally, the field installable EXM provides the ability to grow the FAC 900 cabinet to support rack space for additional fiber distribution endpoints or migration of copper loops to fiber drops (shown below).





FieldSmart® Fiber Active Cabinet (FAC) 900

Installation Manual

Installing a GPON Splitter Cage and Fiber Distribution Bulkhead Frame

This topic describes how to install a GPON splitter cage and fiber distribution frame(s) into the FAC 900 or EXM for GPON applications.

The SC adapter plates are included as part of the GPON splitter cage. Fiber management accessories (fiber spool and routing combs) are included as part of the fiber distribution bulkhead frame.

Note: For enclosures shipped with the GPON splitter integration kit and fiber distribution bulkhead frame(s) installed, skip this topic.

To install a GPON splitter cage and fiber distribution bulkhead frame(s)

- Step 1:** Unpack the GPON splitter cage assembly from its packaging.
- Step 2:** Set aside the following items: fiber staging area, conduit mounting bracket, conduit, (2) conduit fittings, and twine.
- Step 3:** Open the cabinet's side door or EXM door.
- Step 4:** Install the splitter cage assembly as follows:
- Orient the assembly with the fiber tray in the front.
 - Position the assembly against the rear inside of the equipment rail, and the top of the assembly flush against the roof of the enclosure.
 - Align the assembly mounting holes with the counterpart holes in the rear inside of the rail.
 - While holding the assembly against the rack, install four mounting screws (2 per side) to secure the assembly to the rack. Tighten the screws to 45 in. lbs. of torque.
- Step 5:** Unpack the fiber distribution bulkhead frame(s) from its packaging. Set aside the machine screws to later install the fiber termination assemblies.
- Step 6:** Install the fiber distribution bulkhead as follows:
- Orient the bulkhead with the fiber spool on the left.
 - Position the bulkhead flush under the GPON splitter cage assembly, and against the front equipment rail.
 - Align at least two bulkhead mounting holes with the holes on the rail.

FieldSmart® Fiber Active Cabinet (FAC) 900

Installation Manual



d. While holding the bulkhead against the rack, install up to six mounting screws (3 per side) to secure the bulkhead to the rack. Tighten the screws to 45 in. lbs. of torque.

e. To install an additional bulkhead frame(s):

- Orient the bulkhead with the fiber spool on the left.
- Position the bulkhead flush under the installed bulkhead, and against the front equipment rail.
- Repeat steps 5c–5d.

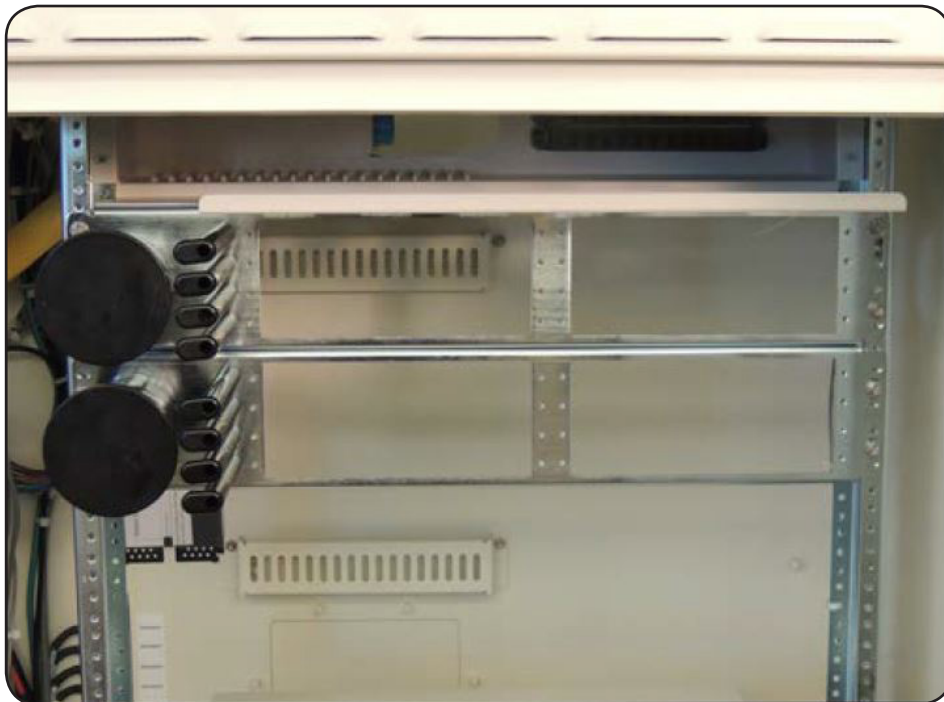



FieldSmart® Fiber Active Cabinet (FAC) 900

Installation Manual

Connecting PON Splitter Fibers to the OLT Equipment

This topic describes how to connect PON splitter fibers to the OLT equipment for an FAC 900 or EXM fiber distribution bulkhead.

The SC adapter plates (for terminating OLT feeder fibers) are installed in the GPON splitter bulkhead frame at the factory.



CAUTION! A Class 1 laser product with an internal Class IIIb hazard is used in this equipment. Use an optical power meter to identify active fibers. Never assume laser power is turned off or that the fiber is disconnected at the other end. A protective cap or hood must be placed over any radiating bulkhead receptacle or optical fiber connector.



IMPORTANT! When routing optic fibers, be careful to avoid bending fibers beyond the manufacturer recommended 1 inch (2.54 cm) bend radius. Exceeding the bend radius can cause excess attenuation and possibly break the fiber.

To connect FAC 900 or EXM PON splitter fibers to the equipment

Step 1: Open the cabinet's side door or EXM door.

Note: For EXM PON splitter installations, this procedure assumes that you have mounted the EXM to the FAC 900.

Step 2: Locate the 1-inch conduit and twine.

Step 3: For a GPON fiber bulkhead installed in the FAC 900, cut the conduit tubing to approximately 2.5 feet.

Step 4: Attach the (2) fittings on each end of the conduit.



FieldSmart® Fiber Active Cabinet (FAC) 900

Installation Manual



Step 5: Feed twine through the conduit as follows:

- a. Hold the conduit vertically and feed approximately 20 feet of twine through the conduit.

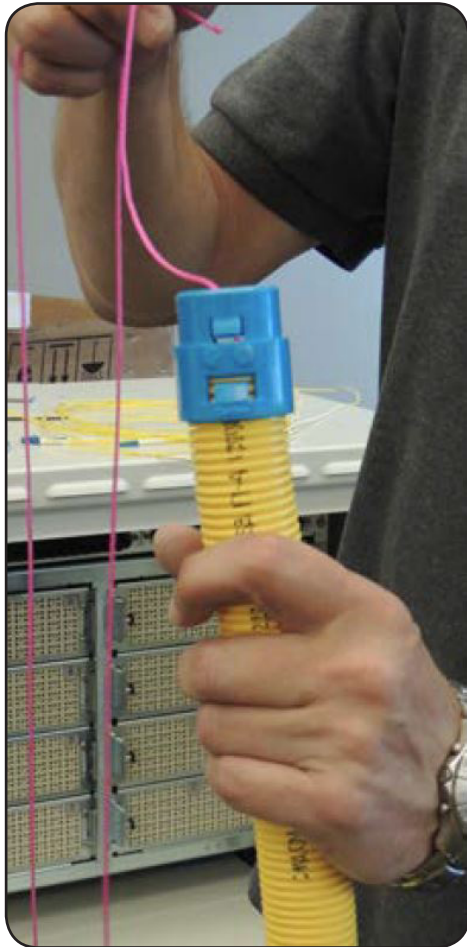

- b. Secure the twine to the inside of each conduit fitting with tape.

Step 6: (Skip this step if your cabinet was shipped with the splitter integration kit installed) Install the conduit mounting bracket in the cabinet as follows:

- a. Locate the conduit mounting bracket (set aside previously).
- b. Position the bracket against the back of the front equipment rail, under the left side of the AC load center or junction box.
- c. Align the bracket mounting holes with the counterpart holes in the rail.



FieldSmart® Fiber Active Cabinet (FAC) 900

Installation Manual

- d. While holding the bracket against the rack, install two mounting screws to secure the bracket to the rack.

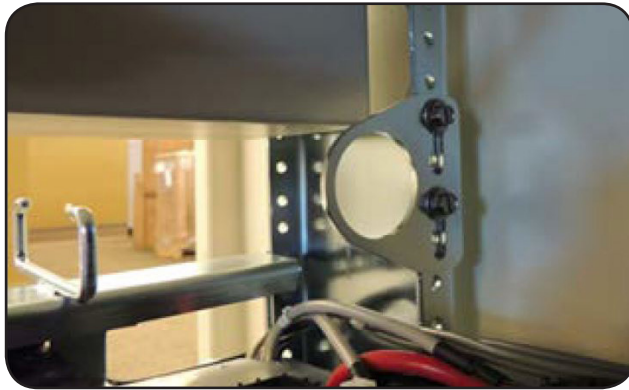

Step 7: Install the conduit in the enclosure as follows:

- a. Orient a conduit fitting toward the mounting bracket in the FAC 900.
- b. Feed the twine through the mounting bracket.
- c. Insert the conduit fitting into the mounting bracket until it snaps in place.

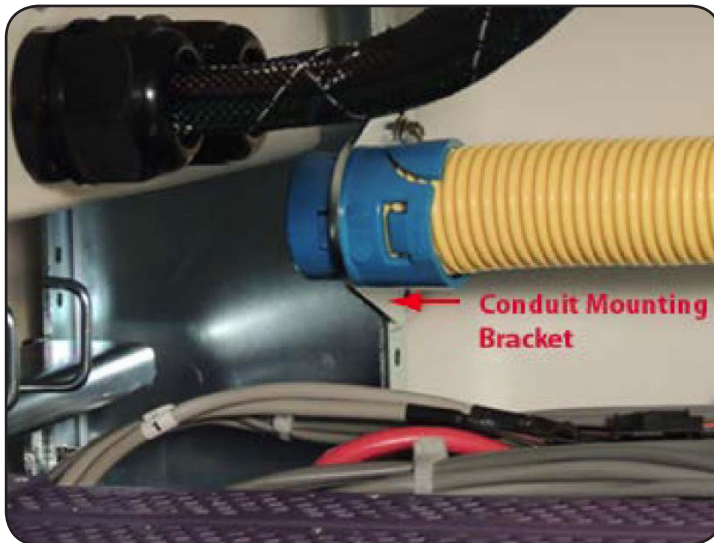

- d. Route the other end of the conduit:
 - to the mounting flange located behind the bulkhead frame in the FAC 900, or
 - through the access panel on the rear cabinet wall, and then to the mounting flange located behind the bulkhead frame in the EXM.
- e. Feed the twine through the mounting flange behind the bulkhead frame.

FieldSmart® Fiber Active Cabinet (FAC) 900

Installation Manual



- f. Insert the conduit fitting into the mounting flange and snap in place.

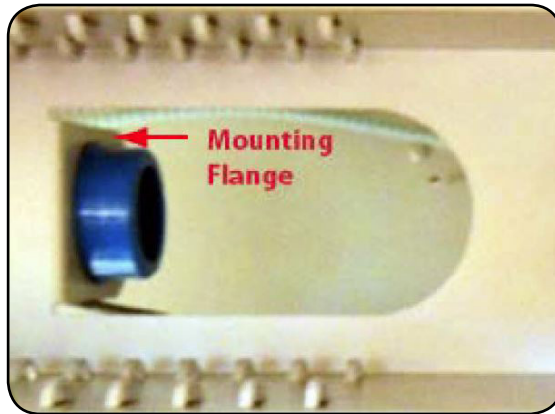

Step 8: Make a fiber pull as follows:

- a. Remove the tape securing the twine to the conduit.
- b. Route one end of the twine along the outside of the conduit until the end.
- c. Tie the ends of the twine together with a looped knot (similar to a bowline knot or fisherman's knot).

Step 9: Feed the fiber jumpers through the conduit as follows:

Note: You may feed the first few fiber jumpers through the conduit without using the fiber pull.

- a. Secure a fiber jumper to the fiber pull (for example, tie the loop in the twine around the jumper connector or tape the jumper to the fiber pull).



Note: You can secure more than one jumper to the fiber pull (for example, stagger and tape jumper connectors on the fiber pull).



FieldSmart® Fiber Active Cabinet (FAC) 900

Installation Manual

- b. Pull on the twine running outside of the conduit to pull the fiber jumper through the conduit until the jumper connector is at the exit end of the conduit.
- c. At the exit end of the conduit, pull the jumper connector through the conduit fitting by hand.
- d. To feed additional fiber jumpers through the conduit, repeat steps 6a–6c, with a second person holding the jumper(s) that has already been pulled through in place from the opposite side of the conduit.

Step 10: Connect the fiber jumper to the SC adapter plate as follows:

- a. At the SC adapter plate, locate the OLT-side fiber (red SC connector).
- b. Route the fiber jumper from the conduit through the SC adapter plate mounting fixture in the bulkhead frame.
- c. Connect the fiber jumper to the corresponding SC connector on rear of the adapter plate.

Step 11: Connect the fiber jumpers to the OLT equipment as follows:

- a. Route the other end of the fiber jumper from the conduit to the service unit.
- b. Connect the fiber jumper to one of the GPON ports.
- c. Neatly dress any slack fiber within the comb duct above the shelf on the front rack.
- d. Repeat steps 7a–7c for each fiber jumper.

Note: Do not reinstall the SC adapter plate in the bulkhead mounting fixture until after connecting PON splitter fibers to the OSP distribution.

FieldSmart® Fiber Active Cabinet (FAC) 900

Installation Manual



Installing a Fiber Termination Assembly

This topic describes how to install a fiber termination assembly on an FAC 900 or EXM fiber distribution bulkhead. A fiber termination assembly consists of bundled (n) 12-position SC/APC distribution cassettes with pre-terminated OSP fiber.

Because the termination cassettes in each assembly are pre-terminated to an OSP fiber bundle, installation requires simply mounting the termination assembly on the bulkhead frame and then routing the OSP cable to the fiber routing duct and then outside of the cabinet (to interface to the outside plant fiber facilities, such as in a fiber hand-hole).

To install a fiber termination assembly

- Step 1:** Unpack the bundled fiber termination assembly from the shipping packaging.
- Step 2:** Locate the machine screws to install the assemblies (either shipped with the fiber distribution bulkhead, or shipped with the enclosure).
- Step 3:** Mount the fiber termination assembly to the bulkhead frame as follows:
- Feed the fiber pigtails on the back of the termination cassettes through the front of the bulkhead frame.
 - Slide the termination assembly into the front of the bulkhead frame.



- Align the mounting holes on fiber termination assembly with the counterpart holes on the frame.

d. Install machine screws to secure the assembly in place.



e. To install additional fiber termination assemblies, repeat steps 2a–2d.

Step 4: Feed the OSP fiber cable down into one of the cabinet's cable entry conduits (and out of the cabinet to the external splicing location).



Step 5: Repeat the steps above to install additional bundled fiber termination assemblies, as needed.

FieldSmart® Fiber Active Cabinet (FAC) 900

Installation Manual



Installing PON Splitter Assemblies and Fibers

This topic describes how to connect PON splitter fibers to the OSP distribution and install PON fiber splitters for an FAC 900 or EXM fiber distribution bulkhead and GPON splitter cage.

Each PON splitter passively splits a single fiber (from an OLT port) 2, 16 or 32 ways toward the OSP facility for service delivery to the ONTs.

The integrated splitter cage can house up to (18) 1:2, 1:16 or 1:32 splitters. The splitter assembly is ordered and packaged separately and installed in the field.



CAUTION! A Class 1 laser product with an internal Class IIIb hazard is used in this equipment. Use an optical power meter to identify active fibers. Never assume laser power is turned off or that the fiber is disconnected at the other end. A protective cap or hood must be placed over any radiating bulkhead receptacle or optical fiber connector.



IMPORTANT! When routing optic fibers, be careful to avoid bending fibers beyond the manufacturer recommended 1 inch (2.54 cm) bend radius. Exceeding the bend radius can cause excess attenuation and possibly break the fiber.

To connect PON splitter fibers to the OSP termination and install splitter assemblies (FAC 900 or EXM)

Step 1: (Skip this step if your cabinet was shipped with the splitter integration kit installed) Install the fiber staging area bracket as follows:

- a. Orient the bracket with the mounting hole on the bottom.
- b. Position the bracket directly under the fiber distribution bulkhead frame, and flush against right enclosure wall.

c. Align the bracket mounting hole with a hole in the front equipment rail.



d. While holding the bracket against the rack, install the mounting screw to secure the staging area to the rack. Tighten the screws to 45 in. lbs. of torque.

e. Place the foam staging plate in the bracket.

Step 2: Pull on the (2) push pins on each side of the SC adapter plate, and remove the plate from the mounting fixture.

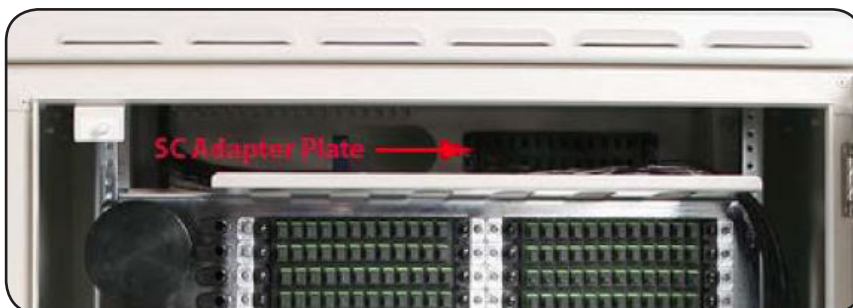

Step 3: Identify the next available position in sequence on the adapter plate and remove the dust cover.

Step 4: Place the adapter plate on the fiber ramp for easy access.

Step 5: Place a PON splitter outside the enclosure (on top of the enclosure or on the ground, for example).

FieldSmart® Fiber Active Cabinet (FAC) 900

Installation Manual



Step 6: Route and terminate the single OLT-side fiber (red SC connector) from the PON splitter (identified as IN) to the SC adapter plate.



IMPORTANT! When routing optic fibers, be careful to avoid bending fibers beyond the manufacturer recommended 1 inch (2.54 cm) bend radius. Exceeding the bend radius can cause excess attenuation and possibly break the fiber.

Step 7: Route and terminate the (2, 16 or 32) PON-side fibers from the splitter to the fiber staging plate (EXM shown below).



Step 8: Route each PON-side fiber from the staging plate to the appropriate position on the fiber assembly and terminate the fiber. Begin with the lower right assembly, and then proceed to the lower left assembly, populating each assembly in sequence with the top left assembly populated last.

Note: For a fully populated enclosure supporting 576 subscriber drops (without an internal battery box), you must route the fibers from the bottom right assembly only to the right and then up the side of the equipment rail and along the notch located on the right side of the fiber ramp. The 51-inch fiber pigtails are not long enough to reach the bottom right assembly for a fully populated configuration.



FieldSmart® Fiber Active Cabinet (FAC) 900

Installation Manual

Step 9: Repeat steps 1–7 for each PON splitter.

Step 10: After terminating all PON-side fibers, install the first splitter terminated to the top left fiber termination assembly as follows:

- a. Dress the fibers from the termination assembly to the left and through the dressing spools as desired, allowing adequate slack.
- b. Route the fibers (and splitter) from the dressing spools to the fiber ramp above the fiber distribution bulkhead.
- c. Insert the splitter into the next available position in sequence (left to right) in the splitter mounting cage.

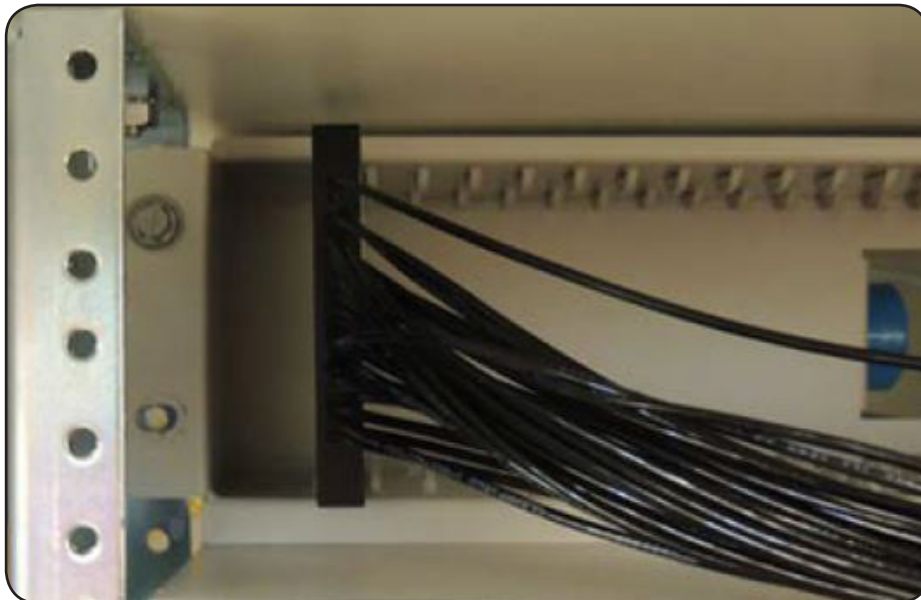

FieldSmart® Fiber Active Cabinet (FAC) 900

Installation Manual



- d. Repeat steps 9a–9c to install the remaining splitters from left to right until you reach the top left assembly.





Step 11: Reinstall the SC adapter plate as follows:

- a. Feed the fibers on the rear of the adapter plate through the mounting fixture into the area behind it.
- b. Position the adapter plate against the mounting fixture.
- c. Align the two push pins on the adapter plate with the holes on the mounting bracket.
- d. Push the push pins to secure the adapter plate in place.
- e. Neatly dress any slack OLT-side fiber along the fiber ramp.

FieldSmart® Fiber Active Cabinet (FAC) 900

Installation Manual



Installing an LGX Case Fiber Distribution Panel

This topic describes how to install a 19-inch 1RU fiber distribution panel, housing up to two Light Guide Cross Connect (LGX) cases. Connect transport fibers from the LGX fiber distribution panel to the Clearfield service unit. Refer to *Connecting Fibers to the Equipment* for more information.

The fiber distribution panel supports the following user-installed LGX cases:

- **Plastic LGX cases:** 6-position (SC or LC connector options) or 12-position (LC connectors) Clearfield Clearview xPAK fiber assemblies supporting a fiber patch cord within the case or spliced to a pre-terminated 100-foot OSP fiber cable. For installation instructions, see the Clearfield Clearview xPAK Installation Note (LGX option).
- **Metal LGX cases:** 6-position (SC or LC connector options) or 12-position (LC connectors) Clearview assemblies with pre-terminated 100-foot OSP fiber cable.

To install a dual LGX fiber distribution panel into an FAC 900 cabinet

Step 1: Unpack the fiber distribution panel from the shipping packaging.

Step 2: Mount the LGX case(s) in the fiber distribution panel as follows:

- a. Feed the fiber pigtail on the back of the LGX case through the front of the panel, if present.
- b. Slide the LGX case into the front of the panel.
- c. Align the captive screws or rivets on the LGX case with the holes on the panel, and tighten to secure the case in place.

Step 3: Install the fiber distribution panel from the rear of the equipment rack as follows:

- a. Open the cabinet's side door.
- b. Orient the panel vertically, and insert the panel top end first, through the space on the right end of the equipment rack **on the outside**.
- c. Align the mounting holes with the counterpart holes on the rack.
- d. While holding the panel against the rack, install four mounting screws (2 per side) using a short Phillips screwdriver to secure the panel to the rack.





FieldSmart® Fiber Active Cabinet (FAC) 900

Installation Manual

Chapter 9: Cabinet Maintenance

This chapter describes how to perform cabinet maintenance, including routine maintenance and corrective maintenance to replace worn or failed parts and equipment.

Topics Covered

This chapter covers the following topics:

- Routine cabinet maintenance
- Replacing parts and equipment

FieldSmart® Fiber Active Cabinet (FAC) 900

Installation Manual



Routine Maintenance

This section describes how to perform routine maintenance on the cabinet.

Checking Cabinet Surfaces

Clean and inspect the cabinet for contaminants, damage, and wear once a year. Items to check include the following:

Inspect interior surfaces

Items to check inside the cabinet include the following:

- Inspect the interior of the cabinet for signs of visible damage to the metal or paint.
- Note any damage to the metal work. If the damaged area interferes with operation of the cabinet or electronics, contact Clearfield support for assistance with a resolution.
- Repair damage to the paint using touch-up paint available from Clearfield after cleaning the surface and removing rust.
- Inspect all gaskets around the doors and the roof to ensure a tight secure fit.

Inspect exterior surfaces

Items to check outside the cabinet include the following:

- Inspect the exterior of the cabinet for signs of damage to the metal work or paint.
- Repair damage to the paint using approved type touch-up paint after cleaning the surface and removing rust.
- Note damage to the metal work. If the damaged area interferes with operation of the cabinet or electronics, contact Clearfield support for assistance with a resolution.
- Clean all surfaces so that they are free of dirt, dust, and foreign material.
- Remove all material from air intake screens and louvers (i.e. spider webs, leaves, etc.).
- Clean the air vents on the heat exchangers and the battery compartment with a dry, soft brush to ensure optimal airflow.

Checking Electrical Components

Check all electrical components in the cabinet for wear at least once a year.

In cabinets configured for local power, inspections include:

- Check the circuit breakers on the AC load center or junction box. Verify that all breakers are in the **ON** position.
- Check the AC surge arrestor on the AC load center or junction box. Verify that the operational indicators are lit.
- Check the GFCI convenience outlet. Test the outlet per local code.
- Check the controller module on the rectifier shelf. Verify that the controller is operational.
- Check the rectifier modules in the shelf. Verify that the modules are operational.
- Check the fuses on the rectifier shelf. Verify that no fuses are blown.
- Check the heat exchanger. Verify that the air intake locations are unobstructed and that the fans are running.

If any of the inspected items requires replacement due to failure or damage, replace the item as described in *Replacing Parts and Equipment*.



FieldSmart® Fiber Active Cabinet (FAC) 900

Installation Manual

Checking Cable Connections

Check external cable connections at least once a year. External cables are any cable that enters the cabinet from the outside plant.

- Visually inspect all cables for signs of physical damage. If damage is present, cables should be repaired or replaced per local practice.
- Check all outside plant copper connections for complete and secure connection.
- Ensure that all cable management accessories provide a clean appearance. Replace any fastening devices (i.e. cable ties) so that they include all cables being secured.
- Check all fiber optic connectors to ensure that they are securely fastened.
- Check all connections on the cabinet ground bar for a tight and secure fit.
- Check all protector modules to ensure that all devices are securely seated.
- Check all conduits to ensure that any material used to seal between the cable and the conduit is still present and providing a complete seal.

Checking the Heat Exchanger



CAUTION! Always disconnect power to the heat exchanger prior to servicing.

Check the heat exchanger for proper functioning at least once a year.

- Verify that no fan failure ENV alarms are present on the Clearfield equipment.
- Verify fan operation, including visual inspection the following:
- Verify that all fans are spinning with no obstructions or odd noises.
- Verify that the heat exchanger is secured to the cabinet and all gasket material is intact and adhered to the cabinet door surface.

Check the heat exchanger for required cleaning based on the environmental conditions (typically once a year).

- Verify that no debris is blocking the inlet and outlet vent screens. Place a piece of paper against the inlet vent and verify that the paper is drawn in; place a piece of paper against the outlet vent and verify that the paper is blown out. Use a whisk broom or other device to clear the vents if debris is present.
- Use a soft bristle brush to remove dust or debris from the fans and heat exchanger core as needed.

Note: If available, you may use low pressure compressed air (up to 30 PSI) in addition to, or in place of, a soft bristle brush. Compressed air should only be used with cabinet doors closed and only on the external sides of the heat exchanger core. Be sure to use appropriate eye protection.

- For more extensive cleaning, you can remove the exterior heat exchanger cover (by removing the two screws at base of the cover) and the individual cover plates behind the main cover.

FieldSmart® Fiber Active Cabinet (FAC) 900

Installation Manual



Battery Maintenance

Perform routine inspection and maintenance of batteries to improve battery life. Follow the manufacturer's maintenance recommendations. Additional general maintenance guidelines are provided below.

Battery maintenance does not impact cabinet service, provided that an AC power failure does not occur during the maintenance process. Clearfield recommends connecting an external generator to the cabinet while performing battery maintenance to ensure service continuity in the event of an AC outage.



WARNING! Electrical hazard. Batteries contain a stored charge. Only a qualified technician should perform this procedure.



CAUTION! Electrical, chemical, fire, and heat hazard. Handle batteries with care to avoid personal injury or damage to the equipment.



ALERT! To ensure service continuity in the event of an AC outage, connect an external generator to the cabinet while performing battery maintenance.

To perform battery maintenance

Step 1: Open the side cabinet door.

Step 2: Open the latch on each side of the terminal cover and remove the cover.

Step 3: Remove the seismic retaining bracket from the internal battery enclosure as follows:

- a. Remove the (2) hex head screws and washers from each side of the retaining bracket.
- b. Rotate the retaining bracket forward, and lift the bracket from the groove at the base of the battery enclosure.

Step 4: Remove the batteries from the battery enclosure:

- a. Disconnect the battery power cables from the power supply leads.
- b. Remove the red and black battery power cables from the terminals at each end of the string.
- c. Remove the jumper straps from between the terminals of batteries in the string.
- d. Slide the batteries out of the battery enclosure.



FieldSmart® Fiber Active Cabinet (FAC) 900

Installation Manual

Step 5: Visually inspect each battery for defects such as:

- Fractured housing or other physical damage
- Leakage
- Bulging

Note: Replace any battery that displays a defect. See *Replacing Batteries* for instructions.

Step 6: Perform the following maintenance tasks:

- a. Load test each battery to verify that ample current is available to maintain the system.
- b. Ensure that each battery provides 13.5 VDC (plus or minus .2 VDC).
- c. Clean each battery to remove dust, dirt, or corrosion from the battery surface.

Note: Only use water for cleaning the battery surface. Do not use any chemicals.

- d. Clean the battery terminals and apply No-Ox anti-corrosion grease to each.
- e. Record the inspection and maintenance details in the cabinet records per local practice.

Step 7: Inspect the battery housing for any signs of damage. Clean the enclosure and fix any damage to painted areas by removing all rust and dirt from the affected area, and then applying touch-up paint to the area to prevent future corrosion.

Step 8: Re-install the batteries into the battery enclosure. See *Installing Batteries* for instructions.

Step 9: Inspect the battery vent on the side cabinet door, and clear any debris from the vent to ensure adequate ventilation for the batteries.

FieldSmart® Fiber Active Cabinet (FAC) 900

Installation Manual



Replacing Parts and Equipment

This section describes how to replace worn or failed parts and equipment in the cabinet.

Removing a Cabinet Door

You can remove the cabinet doors for convenience during cabinet installation or maintenance activities, or to replace a door. Replacing a cabinet door may become necessary if:

- A door becomes damaged.
- The heat exchanger fails or becomes damaged.

You can replace cabinet doors in the field without impacting service.



CAUTION! Handle detached cabinet doors with care to avoid personal injury or damage to the door.

To remove a cabinet door

- Step 1:** For a door (equipped with a heat exchanger), disconnect the heat exchanger cable.
- Step 2:** Disconnect the ground strap from the door by removing the hex nut. Save the nut to re-attach the strap to the new door.
- Step 3:** Disconnect the wind brace bracket from the door:
- a. Remove the three nuts securing the wind brace bracket to the door. Save the nuts to re-attach the bracket to the new door.
 - b. Detach the wind brace bracket from the three studs on the door.





FieldSmart® Fiber Active Cabinet (FAC) 900

Installation Manual

Step 4: On the door hinges, disengage the hinge pin lever from its cradle:

- a. **Top hinge:** Lift the pin lever up and rotate it away from the cradle.
- b. **Bottom hinge:** Press the pin lever down and rotate it away from the cradle.

Step 5: Release the hinge pins from the hinge pin channels as follows:

- a. **Top hinge:** Press down on the pin lever until the pin slides free from the channel.
- b. **Bottom hinge:** Lift up on the pin lever until the pin slides free from the channel.

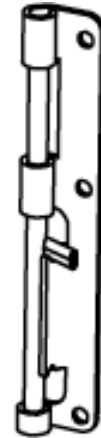

Pin lever engaged

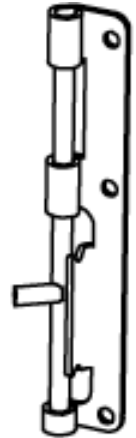

Pin lever disengaged

Step 6: Lift the door away from the cabinet.

Installing a Cabinet Door

Step 1: Unpack the new door from its shipping packaging.

Step 2: Remove the pins from the new door's hinges:

- a. **Top hinge:** Lift the pin lever up and rotate it away from the cradle. Press down on the pin lever until the pin slides free from the channel.
- b. **Bottom hinge:** Press the pin lever down and rotate it away from the cradle. Lift up on the pin lever until the pin slides free from the channel.

Step 3: Insert the new door into the vacant door frame. Align the door hinge knuckles with the counterpart hinge knuckles on the door frame.

Step 4: Engage the hinge pins to secure the door in place as follows:

- a. **Top hinge:** Lift up on the pin lever until the pin slides completely into the pin channel.
- b. **Bottom hinge:** Press down on the pin lever until the pin slides completely into the pin channel.
- c. Rotate the pin levers into the cradles to secure the hinges.



Pin lever engaged

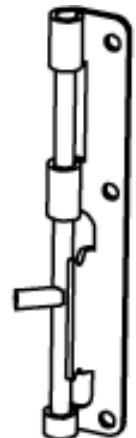

Pin lever disengaged

FieldSmart® Fiber Active Cabinet (FAC) 900

Installation Manual



- Step 5:** Attach the wind brace to the bracket inside the door frame using the nut, bolt, and washer removed from the previous door.
- Step 6:** Attach the ground strap to the door using the hex nut removed from the previous door.
- Step 7:** For a heat exchanger door, connect the heat exchanger power & alarm cable to the cabinet wiring harness.

Replacing AC Breakers

On cabinets configured for local power, if a circuit breaker in the AC load center fails or becomes damaged, you can replace the breaker in the field as described below. If the cabinet is equipped with charged batteries, this procedure does not affect service.



DANGER! High voltage may be present. Only a qualified electrician should perform this task. Follow NEC and local codes when handling power systems. Do not restore AC power until the task is complete.

To replace an AC circuit breaker

- Step 1:** At the local power transfer switch, disconnect AC power to the cabinet.

Note: *If the cabinet is equipped with charged batteries, this action does not affect service. The equipment automatically switches to battery reserve power.*

- Step 2:** At the AC load center, switch the Main circuit breaker to **OFF**.
- Step 3:** Remove the cover panel from the AC load center.
- Step 4:** Remove any wires from the defective circuit breaker.
- Step 5:** Remove the defective breaker from the load center and replace it with a new breaker of the same type and rating.
- Step 6:** Reconnect all wiring to the new circuit breaker.
- Step 7:** Replace the AC load center cover panel.
- Step 8:** At the AC load center, switch all breakers to **ON**.
- Step 9:** At the local power transfer switch, restore AC power to the cabinet.



FieldSmart® Fiber Active Cabinet (FAC) 900

Installation Manual

Replacing Rectifier Modules (Alpha Cordex Rectifier Option)

If an Alpha Cordex HP 1.2kW rectifier module experiences a failure in the field, you can replace the module(s) in the field. Modules are hot-swappable and can be replaced without disconnecting power to the Alpha shelf.

To replace a rectifier module

The rectifier is plug and play. When a rectifier module is added to the system, the Controller will detect and update the inventory automatically. However, replacing an installed rectifier requires a manual Inventory Update at the controller to clear the removed rectifier from its current list of rectifiers.

Step 1: To remove a module, push up on the locking clip release and slide the module out of the shelf.

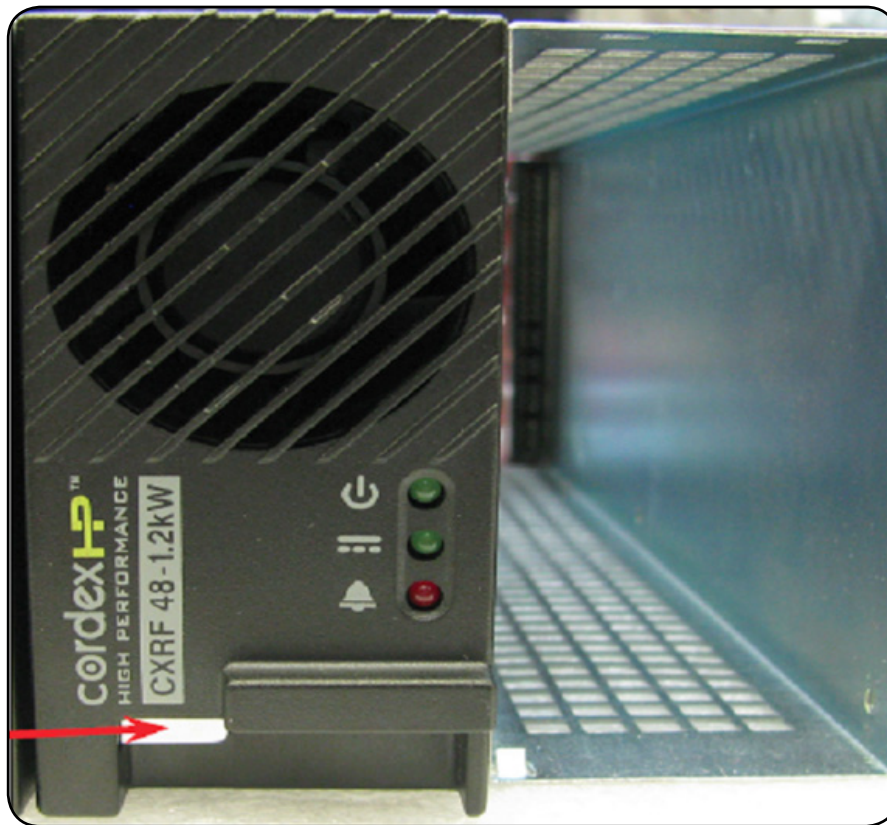

Step 2: At the controller web interface initiate an Inventory Update: **Main Menu > Rectifiers > Inventory Update**.

Step 3: Place the new rectifier module on the shelf bottom and slide the module into the rear connector (inside the shelf).

Step 4: Apply pressure to the module front panel to engage the rear connector in the shelf receptacle.

Step 5: The locking clip automatically secures the rectifier to the shelf.

FieldSmart® Fiber Active Cabinet (FAC) 900

Installation Manual



Replacing Batteries

If a single battery or string of batteries fails, becomes damaged, or wears out its life, you can replace the battery or string as described below. Replacing batteries does not impact cabinet service, provided that an AC power failure does not occur during the replacement process. Clearfield recommends connecting an external generator to the cabinet while performing battery maintenance to ensure service continuity in the event of an AC outage.



WARNING! Electrical hazard. Batteries contain a stored charge. Only a qualified technician should perform this procedure.



CAUTION! Electrical, chemical, fire, and heat hazard. Handle batteries with care to avoid personal injury or damage to the equipment.



ALERT! To ensure service continuity in the event of an AC outage, connect an external generator to the cabinet while performing battery maintenance.

To replace batteries

- Step 1:** Open the side FAC 900 cabinet or EXM front door.
- Step 2:** Open the latch on each side of the terminal cover and remove the cover.
- Step 3:** Remove the seismic retaining bracket from the internal battery enclosure as follows:
- Remove the (2) hex head screws and washers from each side of the retaining bracket.
 - Rotate the retaining bracket forward, and lift the bracket from the groove at the base of the battery enclosure.
- Step 4:** Remove the old batteries:
- Disconnect the #8 AWG battery power cables from the power supply leads.
 - Remove the red and black power cables from the battery string.
 - Remove the jumper straps from between the batteries.
 - Remove the temperature probe cable from the string's negative (-) terminal post.
 - Remove the batteries from the battery enclosure.
- Step 5:** Install the new batteries into the battery enclosure. See *Installing Batteries* for instructions.



Replacing a Battery Heater

If an optional battery heater fails or becomes damaged, you can replace the heater in the field. Replacing a battery heater requires removing the batteries from the battery enclosure.

To replace a battery heater

- Step 1:** Open the side cabinet door.
- Step 2:** Remove the seismic retaining bracket from the internal battery enclosure as follows:
 - a. Remove the (2) hex head screws and washers from each side of the retaining bracket.
 - b. Rotate the retaining bracket forward, and lift the bracket from the groove at the base of the battery enclosure.
- Step 3:** If batteries are present, remove the batteries from the battery enclosure. See *Replacing Batteries* for removal instructions.
- Step 4:** Unplug the heater power cord from the AC outlet (located on the cabinet wall).
- Step 5:** Remove the battery heater from the battery enclosure floor.
- Step 6:** Install the new battery heater into the battery enclosure. Plug the power cord into the AC outlet. See *Installing a Battery Heater* for instructions.
- Step 7:** Re-install and reconnect batteries. See *Installing Batteries* for instructions.

FieldSmart® Fiber Active Cabinet (FAC) 900

Installation Manual



Appendix A: Reference Information

This appendix provides general reference information about the FAC 900 cabinet.

Topics Covered

This appendix covers the following topics:

- Cabinet specifications
- Support matrix for Clearfield service units
- Optional Alpha Cordex HP rectifier alarms and controller settings
- Optional Emerson rectifier alarm matrix
- Optional Emerson rectifier setpoints
- Supported batteries
- Wiring diagrams



FieldSmart® Fiber Active Cabinet (FAC) 900

Installation Manual

Specifications

Specifications for the Clearfield FAC 900 cabinet follow:

Dimensions	
Base cabinet	36" H x 23" W x 48" D
Expansion Module (EXM)	36" H x 24" W x 29" D
Riser options (for base cabinet and/or EXM)	6" H or 12" H (riser only)
Weight	
Standard configuration (base cabinet with equipment shelves, protection blocks and frames, and an internal battery enclosure)	290 lbs
Expansion Module	50 lbs
Internal battery enclosure	25 lbs
Battery string (100Ah)	315 lbs
Enclosure Mounting	
Concrete pad	Clearfield cast-in-place template
Pre-cast concrete pad	Third-party supplied
Foundation vault	Third-party supplied
Wall/H-frame	Clearfield wall/H-frame mounting kit option
Equipment Mounting	
Equipment mounting space	19 inches (8RU); 8RU mounting space for Clearfield service units or third-party equipment
Rack attributes	19-inch EIA standard; oriented for vertical mounting
Environmental	
Heat exchanger	Door mounted Internal fan T _{min} = 30C (50% RPM) and Thigh = 45C (100% RPM) External fan T _{stop} = 30C, T _{min} = 40C (50% RPM) and Thigh = 55C (100% RPM)
Cooling capacity	47 Watts/°C
Thermal operating range	-40C to +46C
Environmental alarming	Environmental
Electrical (Local Power)	
AC load center	208-240 VAC load center Duplex convenience outlet (GFCI protected)
AC junction box (option)	120/240 VAC junction box (2 inputs/2 outputs) Duplex convenience outlet (GFCI protected)
Generator connector (option)	30 Amp NEMA twist-lock (Hubbell)
DC power system	Alpha non-LVD Cordex 1.2HP 1RU Shelf; (3) 1200W (25A) rectifier modules; fuse protected DC Distribution (28 position)
Battery backup	Support for (1) string of front post VRLA or Saft Tel100 Ni-Cd 100Ah batteries [up to (2) 100Ah strings with optional EXM]; battery heater option available for VRLA battery string
Cable Entrance	
Outside plant entry	(1) square feed through accommodating (2) 4.5-inch conduits
AC service entry (local power only)	(1) 2.5-inch diameter entry port
Compliance	
Safety	UL 67
EMC	FCC Part 15, Class A
Telcordia	GR-487-CORE, Issue 2

FieldSmart® Fiber Active Cabinet (FAC) 900

Installation Manual



Alpha Cordex HP Rectifier Alarms and Controller Settings

The Alpha rectifier shelf detects and reports multiple alarm conditions in the cabinet, but only two umbrella alarms are reported through the equipment shelf: Minor (MN) and Major (MJ). For a list of the alarms reported through the equipment shelf as well as parameters and default settings for the Alpha rectifier shelf controller, refer to the *Cordex HP Rectifier Controller Default Configuration* document or for more detailed information refer to the *Alpha Cordex Controller Software Manual*—both available from My Clearfield online (seecclearfield.com).

Supported Batteries

The FAC 900 supports the following batteries. For a list of battery distributors, contact your sales representative.

Manufacturer	Model	Capacity (Ah) per String	Max # of Strings
Northstar	NSB 100FT	100 Ah	1*

* 2 strings are supported when an EXM is mounted on the rear or left side of the base FAC 900 cabinet.

Wiring Diagrams

Wiring diagrams are available on Clearfield's website, seecclearfield.com.



FieldSmart® Fiber Active Cabinet (FAC) 900

Installation Manual

Standard Warranty

Clearfield warrants to the original purchaser of the Product sold hereunder is free from defects in material and workmanship under normal use and service, subject to exceptions stated herein. Product purchased is warranted as follows: Clearfield designed and branded Products are warranted for three (3) years; Products manufactured by Clearfield to customer prints and/or specifications are warranted for one (1) year; and any Product Clearfield acquires from or through a third-party manufacturer or distributor and resells to Customer as the original customer will carry the manufacturer's pass-through warranty, if any. In all cases, the warranty period commences on the date of shipment to the original purchaser.

Warranty Claim Procedure

If any Product purchased from Clearfield is found defective under the above warranty, the following basic procedure must be followed:

1. Customer must contact Clearfield and obtain a Return Materials Authorization
2. Following authorization, the Customer ships the product-freight collect-to Clearfield's manufacturing facility
3. Clearfield shall repair or replace the defective Product at its sole option and discretion, and return the repaired or replacement Product to Customer's site, freight prepaid

Note: If the Product is not found to be defective by Clearfield, the product will be returned to the Customer and the customer billed for freight in both directions.

View our warranty policy here: <https://www.seeclearfield.com/warranty.html>

Limitations of Warranty

Correction of defects by repair or replacement, at the option of Clearfield Inc, shall constitute the exclusive sole remedy for a breach of this limited warranty. Clearfield shall not be liable under any circumstances for any special, consequential, incidental, punitive, or exemplary damages arising out of or in any way connected with the product or with agreement to sell product to buyer, including, but not limited to damages for lost profits, loss of use, or for any damages or sums paid by buyer to third parties. The foregoing limitation of liability shall apply whether the claim is based upon principles of contract, warranty, negligence or other tort, breach of statutory duty, principles of indemnity or contribution, the failure of any limited or exclusive remedy to achieve its essential purpose, or otherwise.

Clearfield will not be responsible for any labor or materials costs associated with installation or incorporation of Clearfield products at customer sites, including any costs of alteration, replacement or defective product, or any field repairs.

Other Limitations

Clearfield assumes no warranty liability regarding defects caused by:

1. Customer's modification of Product, excepting installation activities described in Clearfield documentation
2. Customer re-packaging of Product for shipment to third parties or destinations other than those originally shipped to by Clearfield, or any defects suffered during shipping where the Product has been re-packaged
3. Customer's installation or maintenance, excepting activities described in and performed in accordance with Clearfield documentation
4. Customer's improper or negligent use or application of Product
5. Other causes external to the Product, including but not limited to accidents, catastrophe, acts of God, government action, war, riot, strikes, civil commotion, sovereign conduct, or the acts or conduct of any person or persons not party to or associated with Clearfield
6. Environmental factors and weathering resulting in aging and damage not necessary or applicable to the function of the product

FieldSmart® Fiber Active Cabinet (FAC) 900

Installation Manual



Proprietary Notice

Information contained in this document is copyrighted by Clearfield, Inc. and may not be duplicated in full or part by any person without prior written approval of Clearfield, Inc.

Its purpose is to provide the user with adequately detailed documentation to efficiently install the equipment supplied. Every effort has been made to keep the information contained in this document current and accurate as of the date of publication or revision.

However, no guarantee is given or implied that the document is error free or that it is accurate with regard to any specification.

Technical Support

Clearfield, Inc. can be contacted for any issues that arise with the supplied product.

If you need to return the supplied product, you must contact the Clearfield, Inc. Customer Service Department to request a Returned Materials Authorization (RMA) number.

Clearfield, Inc.
7050 Winnetka Ave N
Minneapolis, MN 55428

Toll Free: 800.422.2537
Phone: 763.476.6866
Fax: 763.475.8457

Customer Support: sales@clfd.net
Technical Support: techsupport@clfd.net